

GRANLUND Tools

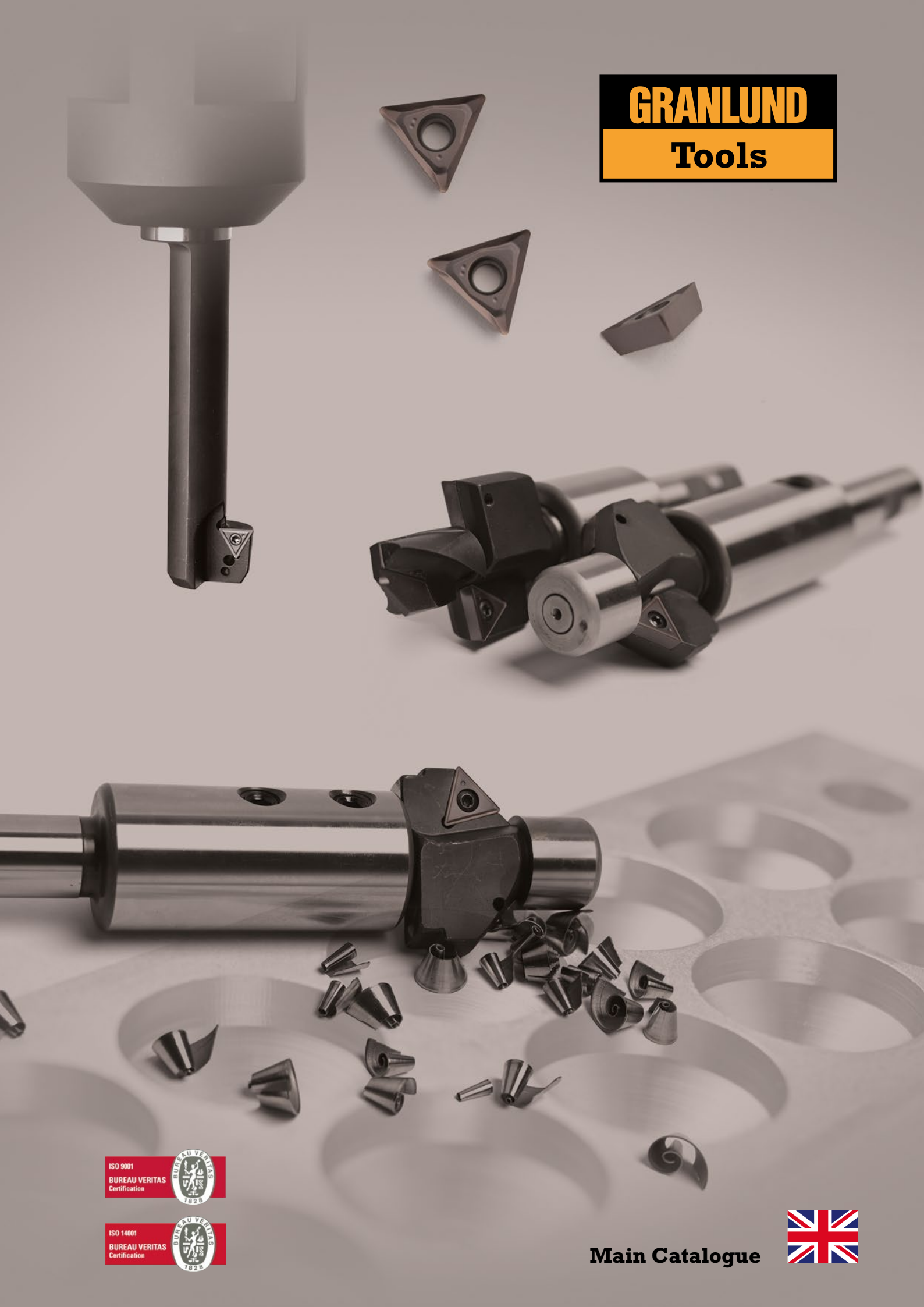

ISO 9001
BUREAU VERITAS
Certification



ISO 14001
BUREAU VERITAS
Certification



Main Catalogue



Counterbore holders for Magnetic drills type MD

Based on increasing requests, Granlund has developed a 19,05 (3/4") / 90 degree Weldon standard holder, that is the most common holder for Magnetic Drills.

These holders are available in System sizes 0, 1 and 2.



New inserts type U

The new U (Universal) inserts are produced with a modern coating and a much more wear resistant substrate for universal applications. Beside from normal machining of steel, the insert has been well approved in applications such as HARDOX™ as well as machining of Stainless.



Long holders with Weldon

After the success with the 1L-500 and 2L-500 cylindrical 500 mm holders, we now fill the gap between those and the longer MT holders.

3 new holders with the length 250 and Weldon are introduced in the series 0,1 and 2.



0L-250-W16

1L-250-W20

2L-250-W25

New insets type SA

The new SA-insert for machining of stainless steel and aluminium, has a sharp cutting edge and a coating optimized for machining of stainless.

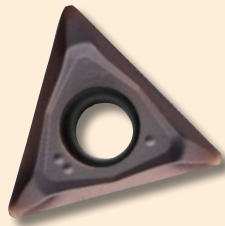

New countersink family type 405

The 405 family is a ground 3 flute countersink with differential pitch. This makes the countersink run very smooth with reduced vibrations. It is supplied both as TIN coated as well as uncoated.

Read more about these on page 25.



New HSS drill for machining of Hardox™

We can now proudly present HSS Drills specially developed for machining of HARDOX™. On the side of our Carbide drill Thunder for HARDOX™, this is a much requested drill, as many operations in HARDOX™ are made in machines that are not suitable for solid carbide tools. The drills are available from 10-40 mm. The drills all have morse taper shank.

More information on page 35.



ISO Colours highlighting different materials added in charts

In order to enhance the difference between materials in our cutting data tables, we now have applied the ISO colours and symbols, such as P for steel, M for stainless, K for cast iron, etc.

HSS Feed mm/rev.	Speed m/min	mm/rev.	Material
0,05 - 0,3	10 - 35	0,05 - 0,3	Steel
0,05 - 0,3	10 - 35	0,05 - 0,3	Cast Steel
0,05 - 0,3	10 - 35	0,05 - 0,3	Stainless Steel
0,05 - 0,3	10 - 35	0,05 - 0,3	Cast Iron
0,05 - 0,3	20 - 50	0,05 - 0,3	Malleable Iron
0,05 - 0,3	10 - 35	0,05 - 0,3	Aluminium Soft
0,05 - 0,3	40 - 80	0,05 - 0,3	Copper
0,05 - 0,3	20 - 80	0,10 - 0,3	HARDOX

We reserve the right to modify any specification and/or item shown in the present catalogue without notice.

Information, photos, drawings and technical data specified in the publication have been carefully examined and thoroughly checked. They cannot, however, bind our responsibility on their exactness.

GRANLUND TOOLS AB, SWEDEN

The company is certified according to ISO 9001 and ISO 14001.



Our Story

Many years ago, to be specific in the early 1945, two skilled metalworkers and foremen were laid off their work at a factory in Gävle. The factory had gone bankrupt and now as a last effort it paid out a reasonable end salary to the best foremen they had. The men were Hilmer Granlund and Börje Gyllhamn.

They were now thinking of what to do next. Johan Nordström, a friend of theirs had bought a factory building in Eskilstuna and suggested them to start business, the three of them. Said and done, they moved to Eskilstuna and started GNG (Granlund, Nordström and Gyllhamn).

Business was picking up and they had work 24/7 due to the infinite demand after the war. Unfortunately, Granlund passed away only one year later at the age of 37. Gyllhamn then bought Granlund's GNG shares from his mother. They also changed the name to H. Granlund & Co in honour of Granlund.

In 1948 Gyllhamn acquired the shares from Nordström, (who a couple of years later founded the company Johan Nordström Verktygsmaskiner AB).

In the coming years, the tool business was developing rapidly, and the export accelerated. Today the export stands for more than 70% of the business.

Since 1948 the company has been a fully family-owned business, and now the third generation operates the business.

Today

Today Granlund Tools is still located in Eskilstuna, Sweden. Granlund is a world-leading manufacturer of precision cutting tools for facing, counterboring, chamfering and backspotfacing. 95% of all tools are manufactured inhouse.

With representation in more than 30 countries, Granlund is a very experienced tool supplier. Granlund has over the years established a well-trimmed and extensive network of distribution as well as a unique and well-established trademark – an obliging trademark!

One plus one may make more than two

One of Granlund Tools' most known products is the interchangeable counterboring system. With only 1300 parts, consisting of holders, cutters, drills and pilots, it is possible to assemble combination tools in more than 1 500 000 separate variations.

Interchangeability is also applicable for other parts of the Granlund Tools' program. For example by the backspotfacing system, consisting of two parts, and the spirabor system with 4 parts. The interchangeability idea is very important also for the development of new tools. We have indeed experienced that one plus one most often make more than two. Granlunds wide tool program suits both modern and older machines.



*Standing from left, Johan Nordström and Börje Gyllhamn
Sitting, Hilmer Granlund - 1945.*



Eric Gyllhamn, Operational Manager in third generation.

Your problem is our challenge

Granlund Tools face problematic machining every day. We have extensive and proven experience with difficult machining, tough materials, advanced special profiles etc. We are proud to say that we are among the best in the world at what we do.

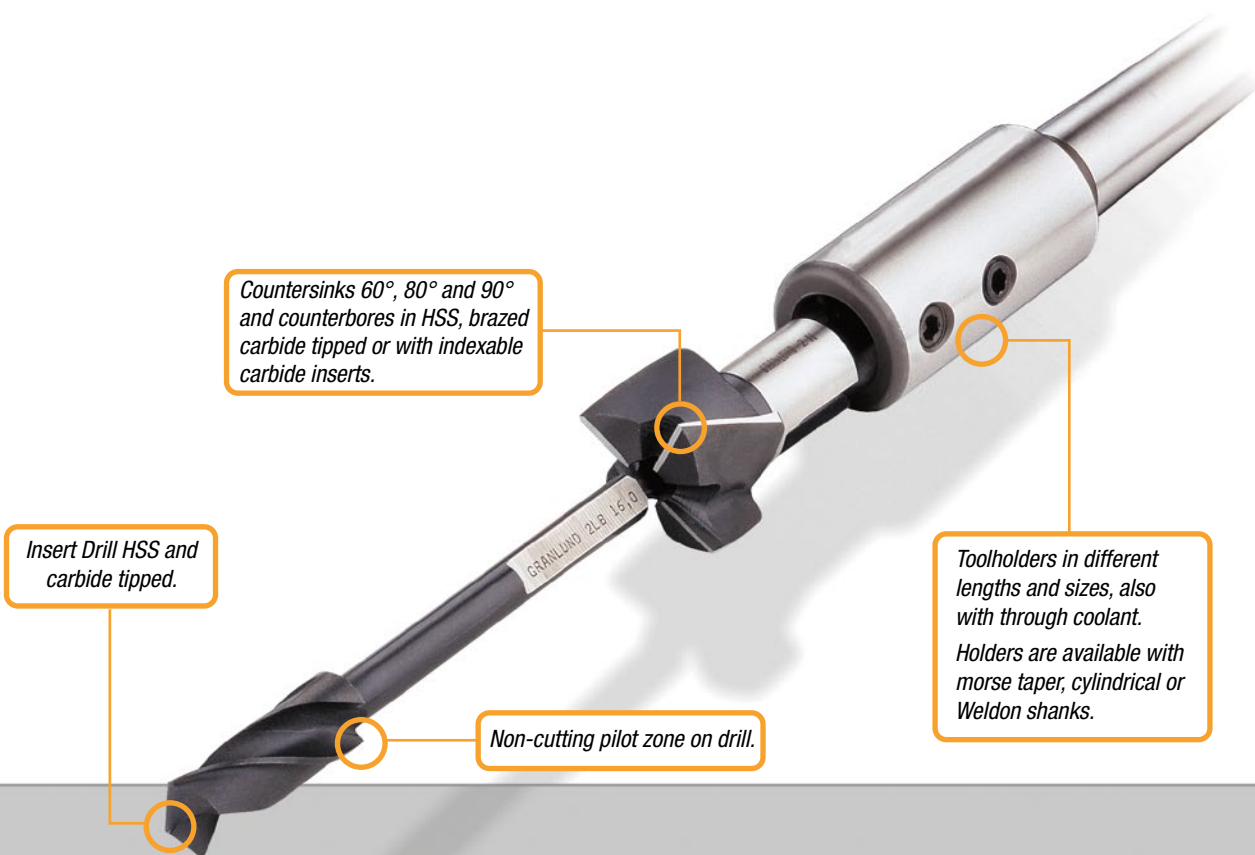

Countersinks 60°, 80° and 90° and counterbores in HSS, brazed carbide tipped or with indexable carbide inserts.

Insert Drill HSS and carbide tipped.

Non-cutting pilot zone on drill.

Toolholders in different lengths and sizes, also with through coolant. Holders are available with morse taper, cylindrical or Weldon shanks.

The Granlund System

Granlund's unique tool system for countersinking and counterboring helps you to increase productivity and lower your costs.

Our toolholders, counterbores, insert drills and pilots may be combined to fit all types of machines and applications.

You can, with only 1300 parts, easily build more than 1 500 000 special tools.

The system is grouped into 4 sizes: size 01, size 0, size 1 and size 2. All combinations have to be made with elements belonging to the same group size. Groups are not interchangeable.

The range of tools available for each group size along with recommendations for correct tool selection and cutting data can be found in the following pages.

	Granlund Counterboring System 6	Counterboring / Countersinking
	Counterboring System Size 01 8 Insert drills, Pilots, Counterbores, Countersinks, Holders, Sets and Inserts	
	Counterboring System Size 0 10 Insert drills, Pilots, Counterbores, Countersinks, Holders and Inserts	
	Counterboring System Size 1 12 Insert drills, Pilots, Counterbores, Countersinks, Holders and Inserts	
	Counterboring System Size 2 15 Insert drills, Pilots, Counterbores, Countersinks, Holders, Inserts and Sets	
	CNC Tools 19 Counterbores, Boring, Chamfering and Face Milling Tools	Backspotfacing
	Countersinks 22 Countersinks type 100, 405 and type FV	
	CNC Backspotfacing / Chamfering Tools 25 CNC Backspotfacers, Back Spotchamfers and Front / Back Spotchamfers, Inserts	
	NEPTUNE 26 Cutting data, Inserts	Reaming
	Backspotfacing System 28	
	Single Flute Reamers RD, RA, RB 30	Centres
	Carbide Reamers, fixed and re-sizeable 32 Reamers, Floating toolholders, Collets	
	Centres 34 Rotating, Carbide tipped, Turning and grinding Centres	Drilling
	THUNDER 35 Drill for HARDOX	
	HARDOX Drill HSS-Co 35	
	Spirabore, Piloted Drill System 36	Balancing
	Balancing Stands 37	
	Technical data 38 Spare parts, Technical data	Technical Data
	Special Tools 39 Special Request form	Special Tools

Tool selection

This table shows pictures of each type of tool and its diameter range within each size (01,0,1,2). Make your tool combination by choosing components from the same size.

Special editions: Insert drills and counterbores HSS all dimensions and system sizes are "Uncoated Blank" as standard. Coatings: TiN, TiCN, FUTURA, HARDLUBE are additional. For price and delivery time, contact your Granlund representative.



Insert drills **Pilots** **Counterbores** **Countersinks**

	B Ø mm	LB Ø mm	BH Ø mm	F Ø mm	R Ø mm	N Ø mm	NA Ø mm	W Ø mm	H Ø mm	HA Ø mm	WHV Ø mm	T Ø mm	TH Ø mm	TK Ø mm	KV Ø mm
01	2,5-3,7	2,5-3,7		2,4-8				5-16				6-10,4			
0	4,2-7	4,2-7	5-6,8	4-5,8	6-14	7-24	7-24	7-16,5	10-24	10-24	18-24	8-16,5			18-25
1	6,5-12	6,5-12	6,5-12	6-6,8	7-24	10-38	10-38	10-25	12-38	12-38	20-38	11,5-30	20-30	16,5-34	20-30
2	11-25	11-25	11-21		10-50	16-85	16-85	16-40	18-75	18-75	34-75	20-85	40-60	30-75	32-60

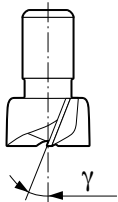

Recommended choice of tool for working in different materials



		N	NA	W	H	HA	WHV	T	TH	TK	KV
	Helix angle (γ)	24°	35°	28°	5°	24°	5°				
P	Steel	•	•	•			•	•		•	•
M	Stainless steel	•	•	•			•	•		•	•
K	Cast iron				•	•	•		•		•
N	Aluminium (Long chips)		•	•			•	•		•	•
	Cast Aluminium (Short chips)					•	•		•		•
	Copper	•	•	•				•		•	
	Bronze/Brass				•	•	•		•		•
H	HARDOX						•				•
X	Plastics soft		•					•		•	
	Plastics hard				•	•			•		



Tool holders

	A	MD	M	NS	DS	L	S	GS	
Morse Taper	MK 1						MK 1		01
Cylindrical Ø mm	6,0 10,0				10		10		
Morse Taper	MK 1-2					MK 1	MK 1		0
Cylindrical Ø mm	8,0 10,0				10		10		
Weldon		W19,05		W 16		W16			
Morse Taper	MK 1-2-3		MK 3	MK 2-3		MK 2	MK 2	MK 3	1
Cylindrical Ø mm	10-12				10	20	10		
Weldon	W 20	W19,05	W 25	W 20		W20		W 25	
Morse Taper	MK 2-3-4-5		MK 3-4	MK 3		MK 3	MK 3	MK 3	2
Cylindrical Ø mm						32			
Weldon	W 20	W19,05	W 32	W 25		W25		W 25	

Cutting data, counterbores and countersinks



	N	NA	W	H	HA	WHV	KV*	T	TK	TH	
Tensile Strength N/mm ² Hardness HB	HSS Speed m/min	HSS Feed mm/rev.	Carbide Speed m/min	Carbide Feed mm/rev.	Carbide Speed m/min	Carbide Feed mm/rev.	HSS Speed m/min	HSS Feed mm/rev.	Carbide Speed m/min	Carbide Feed mm/rev.	Material
<450 N/mm ²	20 - 40	0,10 - 0,5	60 - 130	0,1 - 0,6	75 - 130	0,1 - 0,6	15 - 30	0,05 - 0,3	20 - 50	0,05 - 0,3	Steel
<600 N/mm ²	15 - 30	0,10 - 0,4	50 - 110	0,1 - 0,5	65 - 120	0,1 - 0,5	10 - 25	0,05 - 0,3	15 - 45	0,05 - 0,3	Steel
<1000 N/mm ²	10 - 25	0,05 - 0,3	40 - 110	0,1 - 0,3	55 - 100	0,1 - 0,4	10 - 20	0,05 - 0,3	10 - 40	0,05 - 0,3	Steel
>1000 N/mm ²	5 - 20	0,05 - 0,3	30 - 90	0,1 - 0,2	45 - 90	0,1 - 0,4	5 - 15	0,05 - 0,3	10 - 35	0,05 - 0,3	Steel
<800 N/mm ²	10 - 25	0,05 - 0,3	30 - 90	0,1 - 0,3	45 - 90	0,1 - 0,4	5 - 15	0,05 - 0,3	10 - 35	0,05 - 0,3	Cast Steel
	10 - 20	0,10 - 0,3	20 - 60	0,1 - 0,4	30 - 60	0,1 - 0,3	5 - 15	0,05 - 0,3	10 - 35	0,05 - 0,3	Stainless Steel
<180 HB	20 - 40	0,20 - 0,5	60 - 120	0,2 - 0,5	80 - 120	0,2 - 0,5	10 - 25	0,05 - 0,3	20 - 50	0,05 - 0,3	Cast Iron
<200 HB	20 - 35	0,20 - 0,4	50 - 100	0,2 - 0,4	80 - 120	0,2 - 0,5	10 - 20	0,05 - 0,3	10 - 40	0,05 - 0,3	Cast Iron
<220 HB	10 - 30	0,10 - 0,4	40 - 100	0,2 - 0,4	70 - 110	0,1 - 0,4	5 - 15	0,05 - 0,3	10 - 35	0,05 - 0,3	Cast Iron
<180 HB	20 - 40	0,10 - 0,4	60 - 120	0,2 - 0,5	80 - 120	0,1 - 0,5	15 - 25	0,05 - 0,3	20 - 45	0,05 - 0,3	Malleable Iron
<200 HB	15 - 35	0,10 - 0,4	50 - 110	0,2 - 0,5	75 - 110	0,1 - 0,5	10 - 20	0,05 - 0,3	15 - 40	0,05 - 0,3	Malleable Iron
<220 HB	10 - 30	0,10 - 0,4	40 - 100	0,2 - 0,5	60 - 110	0,1 - 0,4	5 - 15	0,05 - 0,3	10 - 35	0,05 - 0,3	Malleable Iron
	70 - 150	0,05 - 0,5	100 - 350	0,1 - 0,8	80 - 150	0,2 - 1,0	20 - 50	0,05 - 0,3	40 - 80	0,05 - 0,3	Aluminium Soft
	70 - 120	0,05 - 0,5	100 - 350	0,1 - 0,8	100 - 200	0,2 - 1,0	30 - 70	0,05 - 0,3	30 - 70	0,05 - 0,3	Aluminium Hard
	70 - 120	0,10 - 0,5	200 - 350	0,1 - 0,5	100 - 200	0,2 - 1,0	30 - 70	0,05 - 0,3	30 - 70	0,05 - 0,3	Cast Aluminium
	30 - 60	0,10 - 0,5	50 - 150	0,1 - 0,8	80 - 150	0,1 - 0,5	20 - 40	0,05 - 0,3	25 - 80	0,05 - 0,3	Bronze
	40 - 80	0,10 - 0,4	50 - 150	0,1 - 0,4	80 - 200	0,2 - 0,6	20 - 60	0,05 - 0,3	40 - 100	0,05 - 0,3	Brass
	30 - 60	0,10 - 0,4	50 - 150	0,1 - 0,4	50 - 120	0,2 - 0,4	20 - 50	0,05 - 0,3	30 - 80	0,10 - 0,3	Copper
					30 - 60	0,1 - 0,2					HARDOX
	50 - 100	0,10 - 0,5					40 - 80	0,05 - 0,3			Plastics Soft
			70 - 200	0,1 - 0,5	90 - 200	0,2 - 0,5			50 - 80	0,05 - 0,3	Plastics Hard

* Cutting data for type KV = 0,7 x WHV.



Ø mm	Insert drills		Pilots
	B	LB	F
	HSS	HSS	
	Tol.h8 Flute 12 mm	Tol.h8 Flute 17 mm	Tol.c9
	Part No.	Part No.	Part No.
2,4			01F-02,4
2,5	01B-02,5	01LB-02,5	01F-02,5
2,6			01F-02,6
2,7	01B-02,7		01F-02,7
2,9			01F-02,9
3,0	01B-03,0	01LB-03,0	01F-03,0
3,2	01B-03,2	01LB-03,2	01F-03,2
3,3	01B-03,3	01LB-03,3	01F-03,3
3,4	01B-03,4		01F-03,4
3,5	01B-03,5	01LB-03,5	01F-03,5
3,6	01B-03,6		01F-03,6
3,7	01B-03,7	01LB-03,7	01F-03,7
3,9			01F-03,9
4,0			01F-04,0
4,2			01F-04,2
4,5			01F-04,5
4,8			01F-04,8
5,0			01F-05,0
5,3			01F-05,3
5,5			01F-05,5
6,0			01F-06,0
6,4			01F-06,4
6,5			01F-06,5
6,6			01F-06,6
6,8			01F-06,8
7,0			01F-07,0
7,5			01F-07,5
8,0			01F-08,0

Ø mm	Counterbores and countersinks	
	W	T
	HSS	HSS
	Tol.p8 Flute 16 mm	Tol.x9 Flute 16 mm
	Part No.	Part No.
5,0	01W-05,0	
5,5	01W-05,5	
5,9	01W-05,9	
6,0	01W-06,0	01T9-06,0
6,3	01W-06,3	01T9-06,3
6,4	01W-06,4	
6,5	01W-06,5	
6,7	01W-06,7	01T9-06,7
6,8	01W-06,8	
7,0	01W-07,0	01T9-07,0
7,3		01T9-07,3
7,5	01W-07,5	
8,0	01W-08,0	01T9-08,0
8,3		01T9-08,3
8,5	01W-08,5	
8,6		01T9-08,6
9,0	01W-09,0	
9,4		01T9-09,4
9,5	01W-09,5	
10,0	01W-10,0	01T9-10,0
10,4	01W-10,4	01T9-10,4
10,5	01W-10,5	
11,0	01W-11,0	
12,0	01W-12,0	
12,5	01W-12,5	
13,0	01W-13,0	
14,0	01W-14,0	
15,0	01W-15,0	
16,0	01W-16,0	

B and LB

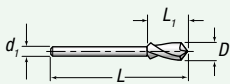

Important!

- When using insert drills, the drill must drill through before the countersink/countersink starts to cut. Insert drill must not be used in blind holes.

Type	d_i	L	L_i
B	2,4	47,0	12,0
LB	2,4	52,0	17,0

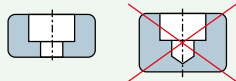

W

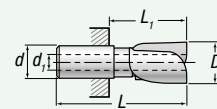

Type	d	d_i	L	L_i
W	7,0	2,4	28,0	16,0

F

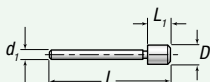

Type	d_i	L	L_i
F	2,4	40,0	6,0

T

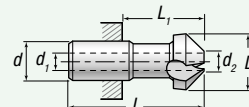

Type	d	d_i	d_{2min}	L	L_i
T	7,0	2,4	2,7	28,0	16,0

Size 01



Tool holders

A

Shank	Part No.
MK1	01A-MK1
Ø6	01A-06
Ø10	01A-10



Tool holders

S

With rotating depth-stop

Shank	Part No.
MK1	01S-MK1
Ø10	01S-10



Tool holders

DS

Shank	Part No.
Ø10	01DS-10

Set		
Part No. 01P / M3-M6		
Counterbores type W, Ø mm	Pilots type F, Ø mm	Tool holders
5,0	2,4	01A-06 mm
5,5	2,5	
6,0	3,0	
6,5	3,2	
7,0	3,4	
7,5	3,5	
8,0	3,6	
8,5	4,0	
9,0	4,2	
9,5	4,5	
10,0	5,0	
10,5	5,5	
11,0	6,0	
	6,5	
	6,6	
	7,0	

01DS

Type	D Tol. g7	d	L	L ₁	Shank
01DS-10	14	7	54	25	Ø10

01A

Type	D Tol. g7	d	L	L ₁	Shank
01A-MK1	14	7	120	58	MK1
01A-06	14	7	86	45	Ø6
01A-10	14	7	86	45	Ø10

01S

Type	D	d	L	L ₁	L ₂	Shank
01S-MK1	30	7	120	59	16	MK1
01S-10	30	7	88	59	16	Ø10

Size 0



Ø mm	Insert drills			Pilots		Counterbores and countersinks							
	B	LB	BH	F	R	N	NA	W	H	HA	WHV	T	KV
	HSS	HSS	Carbide K20 micrograin	Fixed	Roller	HSS	HSS	HSS	Carbide K40 micrograin	Carbide K10 micrograin	For carbide Inserts	HSS 90°	For carbide Inserts
	Tol.h8 Flute 15 mm	Tol.h8 Flute 27 mm	Tol.h8 Flute 15 mm	Tol. c9	Tol. c9	Tol.p8	Tol.p8	Tol.p8	Tol.p8	Tol.p8	Tol.±0,1	Tol.x9	+0,2 -0
Part No.	Part No.	Part No.	Part No.	Part No.	Part No.	Part No.	Part No.	Part No.	Part No.	Part No.	Part No.	Part No.	Part No.
4,0				OF-04,0*									
4,2	OB-04,2*	OLB-04,2*		OF-04,2*									
4,3	OB-04,3*	OLB-04,3*		OF-04,3*									
4,5	OB-04,5*	OLB-04,5*		OF-04,5*									
4,8	OB-04,8*	OLB-04,8*		OF-04,8*									
5,0	OB-05,0*	OLB-05,0*	OBH-05,0*	OF-05,0*									
5,1	OB-05,1*	OLB-05,1*											
5,3	OB-05,3*	OLB-05,3*		OF-05,3*									
5,5	OB-05,5*	OLB-05,5*		OF-05,5*									
5,8	OB-05,8	OLB-05,8		OF-05,8									
6,0	OB-06,0	OLB-06,0	OBH-06,0	OF-06,0	OR-06,0								
6,4	OB-06,4	OLB-06,4		OF-06,4	OR-06,4								
6,5	OB-06,5	OLB-06,5	OBH-06,5	OF-06,5	OR-06,5								
6,6	OB-06,6	OLB-06,6		OF-06,6	OR-06,6								
6,8	OB-06,8	OLB-06,8	OBH-06,8	OF-06,8	OR-06,8								
7,0	OB-07,0	OLB-07,0		OF-07,0	OR-07,0	ON-07,0	ONA-07,0	OW-07,0					
7,4				OF-07,4		ON-07,4	ONA-07,4						
7,5	* Not to be used with carbide cutters.			OF-07,5	OR-07,5	ON-07,5	ONA-07,5	OW-07,5					
7,6				OF-07,6									
8,0				OF-08,0	OR-08,0	ON-08,0	ONA-08,0	OW-08,0				OT9-08,0	
8,3				OF-08,3	OR-08,3							OT9-08,3	
8,4				OF-08,4	OR-08,4								
8,5				OF-08,5	OR-08,5	ON-08,5	ONA-08,5	OW-08,5					
8,6												OT9-08,6	
9,0				OF-09,0	OR-09,0	ON-09,0	ONA-09,0	OW-09,0					
9,4						ON-09,4						OT9-09,4	
9,5				OF-09,5	OR-09,5	ON-09,5	ONA-09,5	OW-09,5					
10,0				OF-10,0	OR-10,0	ON-10,0	ONA-10,0	OW-10,0	OH-10,0			OT9-10,0	
10,2				OF-10,2									
10,4						ON-10,4		OW-10,4				OT9-10,4	
10,5				OF-10,5	OR-10,5	ON-10,5		OW-10,5	OH-10,5	OHA-10,5			
11,0				OF-11,0	OR-11,0	ON-11,0	ONA-11,0	OW-11,0	OH-11,0	OHA-11,0			
11,5				OF-11,5		ON-11,5	ONA-11,5	OW-11,5	OH-11,5	OHA-11,5		OT9-11,5	
12,0				OF-12,0	OR-12,0	ON-12,0	ONA-12,0	OW-12,0	OH-12,0	OHA-12,0		OT9-12,0	
12,4												OT9-12,4	
12,5				OF-12,5	OR-12,5	ON-12,5	ONA-12,5	OW-12,5	OH-12,5				
13,0				OF-13,0	OR-13,0	ON-13,0	ONA-13,0	OW-13,0	OH-13,0	OHA-13,0		OT9-13,0	
13,4												OT9-13,4	
13,5				OF-13,5	OR-13,5	ON-13,5	ONA-13,5						
14,0				OF-14,0	OR-14,0	ON-14,0	ONA-14,0	OW-14,0	OH-14,0	OHA-14,0		OT9-14,0	
14,5						ON-14,5	ONA-14,5		OH-14,5				
15,0						ON-15,0	ONA-15,0	OW-15,0	OH-15,0	OHA-15,0		OT9-15,0	
15,5						ON-15,5	ONA-15,5	OW-15,5					
16,0						ON-16,0	ONA-16,0	OW-16,0	OH-16,0	OHA-16,0		OT9-16,0	
16,4												OT9-16,4	
16,5						ON-16,5	ONA-16,5	OW-16,5				OT9-16,5	
17,0						ON-17,0	ONA-17,0		OH-17,0				
17,5						ON-17,5	ONA-17,5						
18,0						ON-18,0	ONA-18,0		OH-18,0	OHA-18,0	OWHV-18,0		OKV9-18,0
18,5						ON-18,5							
19,0						ON-19,0	ONA-19,0		OH-19,0		OWHV-19,0		OKV9-19,0
19,5						ON-19,5							
20,0						ON-20,0	ONA-20,0		OH-20,0	OHA-20,0	OWHV-20,0		
20,5						ON-20,5	ONA-20,5						OKV9-20,5
21,0						ON-21,0	ONA-21,0		OH-21,0		OWHV-21,0		
21,5						ON-21,5	ONA-21,5						
22,0						ON-22,0	ONA-22,0		OH-22,0	OHA-22,0	OWHV-22,0		
22,5						ON-22,5	ONA-22,5						
23,0						ON-23,0	ONA-23,0		OH-23,0		OWHV-23,0		
23,5							ONA-23,5						
24,0						ON-24,0	ONA-24,0		OH-24,0	OHA-24,0	OWHV-24,0		
25,0													OKV9-25,0

B, LB and BH

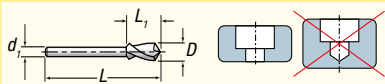

Type	d ₁	L	L ₁
B, BH	4,0	70,0	15,0
LB	4,0	82,0	27,0

Important!

- When using insert drills, the drill must drill through before the countersink/countersink starts to cut. Insert drill must not be used in blind holes.

F and R

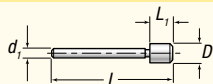

Type	d ₁	L	L ₁
F, R	4,0	64,0	9,0

Important!

- When working "dry" type R roller pilots must be lubricated.

N, NA och W

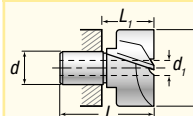

Type	d	d ₁	d _{2min}	L	L ₁
N, NA, W	10,0	4,0		40,0	22,0
H, HA, WH	10,0	4,0	5,8	40,0	22,0
WHV	10,0	4,0	5,2	40,0	22,0

H and HA

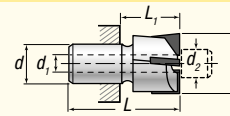

WHV

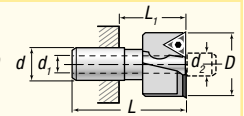

Important!

- The counterbore WHV Rotatip should always be used combined with type R roller pilots.

Size 0



Tool holders

A

Shank	Part No.
MK1	0A-MK1
MK2	0A-MK2
Ø8	0A-08
Ø10	0A-10

Tool holders

NS and DS
Short

Shank	Part No.
Weldon	
W16	ONS-W16
Ø10	ODS-10

Tool holders

L
Long

Shank	Part No.
MK1	
L100	OL-100-MK1
L150	OL-150-MK1
L200	OL-200-MK1
Weldon	OL-250-W25

Tool holders

S
With rotating depthstop

Shank	Part No.
MK1	OS-MK1
Ø10	OS-10

Tool holders

MD
Magnetic drills

Shank	Part No.
W19,05	OMD

Important!

- When using carbide cutters – types TH, H and HA – set the axial adjusting screw to contact the shank of inserted pilot or drill.
- Allow a gap between the shoulder of the pilot/drill and the carbide cutting edges to prevent damage by accidental impact.
- The adjusting screw is also used to extend the life of insert drills after regrinding.

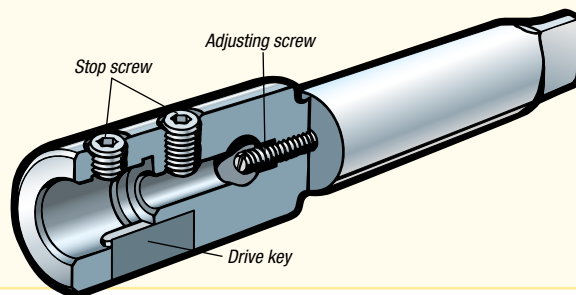

Insert for WHV and KV

Type of insert	Size	Part No.	Part No.	Radius	Suitable for	SSK
WHV 18,0 - 20,0 KV 20,0 - 25,0	07	TPMT-07U	TPMR-07U	0,4	Universal	20
	07		TPMR-07U	0,4	HARDOX	
	07	TPMT-07SA		0,4	Stainless	
	07	TPMT-07SA		0,4	Aluminium	

• The GRANLUND inserts have special chipbreaker angle for optimum chip control.

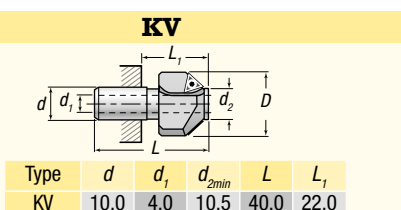
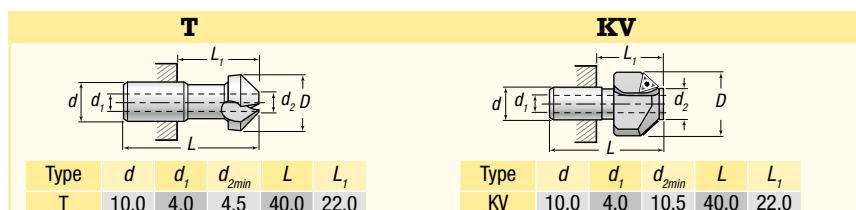
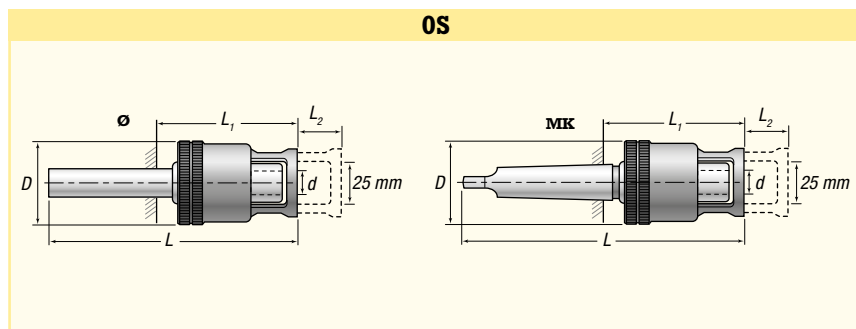

Important!

- The countersinks KV should always be used combined with type R roller pilots.

0MD

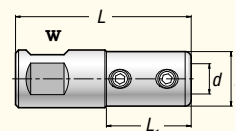

0A

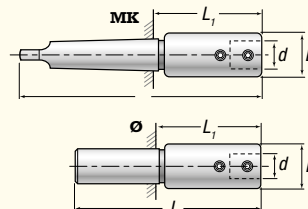

ONS **ODS**

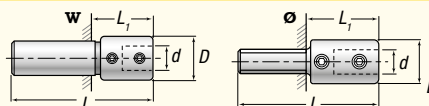

0L

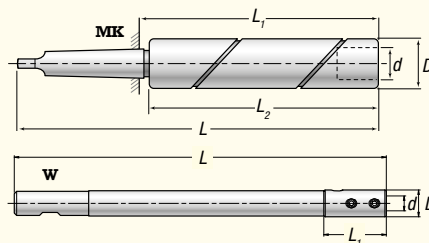

Type	D Tol. g7	d	L	L ₁	L ₂	Shank
0A-MK1	18	10	110	48		MK1
0A-MK2	18	10	132	57		MK2
0A-08	18	10	92	42		Ø8
0A-10	18	10	92	42		Ø10
OS-MK1	37	10	114	53	18	MK1
OS-10	37	10	96	53	18	Ø10
OL-100-MK1	20	10	168	106	100	MK1
OL-150-MK1	20	10	218	156	150	MK1
OL-200-MK1	20	10	268	206	200	MK1
OL-250-W16	18	10	250	42		W16
ONS-W16	18	10	80	28		W16
ODS-10	18	10	58	30		Ø10
OMD	18	10	58	28		W19,05

Size 1

GRANLUND
Tools



Ø mm	Insert drills			Pilots	
	B	LB	BH	F	R
	HSS	HSS	Carbide K20 micrograin	Fixed	Roller
	Tol. h8 Flute 25 mm	Tol. h8 Flute 40 mm	Tol. h8 Flute 25 mm	Tol. c9	Tol. c9
	Part No.	Part No.	Part No.	Part No.	Part No.
6,0				1F-06,0*	
6,4				1F-06,4*	
6,5	1B-06,5*	1LB-06,5*	1BH-06,5*	1F-06,5*	
6,6	1B-06,6*	1LB-06,6*		1F-06,6*	
6,8	1B-06,8*	1LB-06,8*	1BH-06,8*	1F-06,8*	
7,0	1B-07,0*	1LB-07,0*	1BH-07,0*	1F-07,0*	1R-07,0*
7,4				1F-07,4*	
7,5	1B-07,5*	1LB-07,5*		1F-07,5*	1R-07,5*
7,6	1B-07,6*	1LB-07,6*		1F-07,6*	
7,9	1B-07,9*	1LB-07,9*			
8,0	1B-08,0	1LB-08,0	1BH-08,0	1F-08,0	1R-08,0
8,2	1B-08,2	1LB-08,2			
8,3				1F-08,3	1R-08,3
8,4	1B-08,4	1LB-08,4		1F-08,4	1R-08,4
8,5	1B-08,5	1LB-08,5	1BH-08,5	1F-08,5	1R-08,5
8,8	1B-08,8	1LB-08,8			
9,0	1B-09,0	1LB-09,0	1BH-09,0	1F-09,0	1R-09,0
9,3	1B-09,3	1LB-09,3			
9,5	1B-09,5	1LB-09,5		1F-09,5	1R-09,5
10,0	1B-10,0	1LB-10,0	1BH-10,0	1F-10,0	1R-10,0
10,2	1B-10,2	1LB-10,2		1F-10,2	1R-10,2
10,5	1B-10,5	1LB-10,5	1BH-10,5	1F-10,5	1R-10,5
10,7	1B-10,7				
11,0	1B-11,0	1LB-11,0	1BH-11,0	1F-11,0	1R-11,0
11,5	1B-11,5	1LB-11,5	1BH-11,5	1F-11,5	1R-11,5
11,6	1B-11,6	1LB-11,6			
12,0	1B-12,0	1LB-12,0	1BH-12,0	1F-12,0	1R-12,0
12,5				1F-12,5	1R-12,5
13,0				1F-13,0	1R-13,0
13,5				1F-13,5	1R-13,5
14,0				1F-14,0	1R-14,0
14,5				1F-14,5	1R-14,5
15,0				1F-15,0	1R-15,0
15,5				1F-15,5	1R-15,5
16,0				1F-16,0	1R-16,0
16,5				1F-16,5	1R-16,5
17,0				1F-17,0	1R-17,0
17,5				1F-17,5	1R-17,5
18,0				1F-18,0	1R-18,0
18,5				1F-18,5	1R-18,5
19,0				1F-19,0	1R-19,0
20,0				1F-20,0	1R-20,0
20,5					1R-20,5
21,0					1R-21,0
22,0					1R-22,0
22,5					1R-22,5
23,0					1R-23,0
24,0					1R-24,0

* Not be used with carbide cutters.

Ø mm	Counterbores					
	N	NA	W	H	HA	WHV
	HSS	HSS	HSS	Carbide K40 micrograin	Carbide K10 micrograin	For carbide inserts
	Tol. p8	Tol. p8	Tol. p8	Tol. p8	Tol. p8	Tol. ± 0,1
	Part No.	Part No.	Part No.	Part No.	Part No.	Part No.
10,0	1N-10,0	1NA-10,0	1W-10,0			
10,4		1NA-10,4				
10,5	1N-10,5	1NA-10,5	1W-10,5			
11,0	1N-11,0	1NA-11,0	1W-11,0			
11,5	1N-11,5	1NA-11,5	1W-11,5			
12,0	1N-12,0	1NA-12,0	1W-12,0	1H-12,0	1HA-12,0	
12,5	1N-12,5	1NA-12,5	1W-12,5	1H-12,5	1HA-12,5	
13,0	1N-13,0	1NA-13,0	1W-13,0	1H-13,0	1HA-13,0	
13,5	1N-13,5	1NA-13,5	1W-13,5	1H-13,5	1HA-13,5	
14,0	1N-14,0	1NA-14,0	1W-14,0	1H-14,0	1HA-14,0	
14,5	1N-14,5	1NA-14,5			1HA-14,5	
15,0	1N-15,0	1NA-15,0	1W-15,0	1H-15,0	1HA-15,0	
15,5	1N-15,5	1NA-15,5		1H-15,5	1HA-15,5	
16,0	1N-16,0	1NA-16,0	1W-16,0	1H-16,0	1HA-16,0	
16,5	1N-16,5	1NA-16,5	1W-16,5	1H-16,5	1HA-16,5	
17,0	1N-17,0	1NA-17,0	1W-17,0	1H-17,0	1HA-17,0	
17,5	1N-17,5	1NA-17,5	1W-17,5	1H-17,5	1HA-17,5	
18,0	1N-18,0	1NA-18,0	1W-18,0	1H-18,0	1HA-18,0	
18,5	1N-18,5	1NA-18,5		1H-18,5	1HA-18,5	
19,0	1N-19,0	1NA-19,0	1W-19,0	1H-19,0	1HA-19,0	
19,5	1N-19,5	1NA-19,5		1H-19,5	1HA-19,5	
20,0	1N-20,0	1NA-20,0	1W-20,0	1H-20,0	1HA-20,0	1WHV-20,0
20,5	1N-20,5	1NA-20,5		1H-20,5	1HA-20,5	1WHV-20,5
21,0	1N-21,0	1NA-21,0	1W-21,0	1H-21,0	1HA-21,0	1WHV-21,0
21,5	1N-21,5	1NA-21,5	1W-21,5	1H-21,5	1HA-21,5	1WHV-21,5
22,0	1N-22,0	1NA-22,0	1W-22,0	1H-22,0	1HA-22,0	1WHV-22,0
22,5	1N-22,5	1NA-22,5		1H-22,5	1HA-22,5	
23,0	1N-23,0	1NA-23,0	1W-23,0	1H-23,0	1HA-23,0	1WHV-23,0
23,5	1N-23,5	1NA-23,5		1H-23,5	1HA-23,5	
24,0	1N-24,0	1NA-24,0	1W-24,0	1H-24,0	1HA-24,0	1WHV-24,0
24,5	1N-24,5	1NA-24,5		1H-24,5	1HA-24,5	
25,0	1N-25,0	1NA-25,0	1W-25,0	1H-25,0	1HA-25,0	1WHV-25,0
25,5	1N-25,5	1NA-25,5		1H-25,5	1HA-25,5	1WHV-25,5
26,0	1N-26,0	1NA-26,0		1H-26,0	1HA-26,0	1WHV-26,0
26,5	1N-26,5	1NA-26,5		1H-26,5	1HA-26,5	
27,0	1N-27,0	1NA-27,0		1H-27,0	1HA-27,0	1WHV-27,0
27,5	1N-27,5	1NA-27,5		1H-27,5	1HA-27,5	
28,0	1N-28,0	1NA-28,0		1H-28,0	1HA-28,0	1WHV-28,0
28,5	1N-28,5	1NA-28,5		1H-28,5	1HA-28,5	
29,0	1N-29,0	1NA-29,0		1H-29,0	1HA-29,0	1WHV-29,0
29,5	1N-29,5	1NA-29,5				
30,0	1N-30,0*	1NA-30,0*		1H-30,0*	1HA-30,0*	1WHV-30,0
30,5	1N-30,5*	1NA-30,5*			1HA-30,5*	1WHV-30,5
31,0	1N-31,0*	1NA-31,0*			1HA-31,0*	1WHV-31,0
32,0	1N-32,0*	1NA-32,0*		1H-32,0*	1HA-32,0*	1WHV-32,0
33,0	1N-33,0*	1NA-33,0*		1H-33,0*	1HA-33,0*	1WHV-33,0
34,0	1N-34,0*	1NA-34,0*		1H-34,0*	1HA-34,0*	1WHV-34,0
35,0	1N-35,0*	1NA-35,0*		1H-35,0*	1HA-35,0*	1WHV-35,0
36,0	1N-36,0*	1NA-36,0*		1H-36,0*	1HA-36,0*	1WHV-36,0
37,0	1N-37,0*	1NA-37,0*		1H-37,0*	1HA-37,0*	1WHV-37,0
38,0	1N-38,0*	1NA-38,0*		1H-38,0*	1HA-38,0*	1WHV-38,0

B, LB and BH

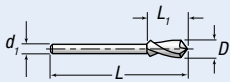

Type	d ₁	L	L ₁
B, BH	6,0	95,0	25,0
LB	6,0	110,0	40,0

Important!

- When using insert drills, the drill must drill through before the countersink/countersink starts to cut. Insert drill must not be used in blind holes.

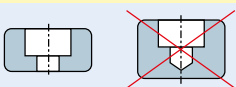

F and R/RS

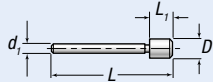

Type	d ₁	L	L ₁
F, R	6,0	80,0	14,0

* 1R < Ø10 mm, L1=9,0 mm

Important!

- When working "dry" type R roller pilots must be lubricated.

N, NA and W

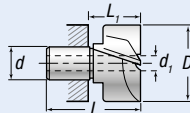

Type	d	d ₁	d _{2min}	L	L ₁
N, NA, W	14,0	6,0		48,0	28,0
H, HA, WH	14,0	6,0	8,0	48,0	28,0

Important!

- Counterbores N, NA, H and HA Ø 30 mm and larger are all made with a driving lip. These sizes should be used in the appropriate type M toolholder.

H and HA

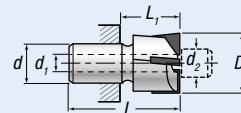

WHV

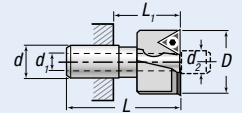

Type	d	d ₁	d _{2min}	L	L ₁
WHV	14,0	6,0	7,6	48,0	28,0

Important!

- The counterbore WHV Rotatip should always be used combined with roller pilots. The shank of the holder must not be smaller than MT2. The minimum size of the pilot shall be Ø 11 mm for counterboring and Ø 6 mm for spotfacing.

Size 1

GRANLUND
Tools



Ø mm	Countersinks					
	T	T	T	TH	TK	KV
	HSS	HSS	HSS	Carbide K 10	HSS	For carbide inserts
	Tol. x9 60°	Tol. x9 80°	Tol. x9 90°	Tol. x9 90°	Tol. x9 90°	Tol. + 0,2-0 90°
Part No.	Part No.	Part No.	Part No.	Part No.	Part No.	
11,5			1T9-11,5			
12,0			1T9-12,0			
12,4			1T9-12,4			
13,4			1T9-13,4			
14,0	1T6-14,0	1T8-14,0	1T9-14,0			
15,0			1T9-15,0			
16,0	1T6-16,0		1T9-16,0			
16,4			1T9-16,4			
16,5			1T9-16,5		1TK9-16,5	
18,0	1T6-18,0		1T9-18,0			
19,0			1T9-19,0			
20,0	1T6-20,0		1T9-20,0	1TH9-20,0	1TK9-20,0	1KV9-20,0
20,5			1T9-20,5			
22,0			1T9-22,0			
23,0			1T9-23,0			
25,0	1T6-25,0	1T8-25,0	1T9-25,0		1TK9-25,0	
26,0			1T9-26,0			1KV9-26,0
28,0			1T9-28,0			
30,0	1T6-30,0	1T8-30,0	1T9-30,0	1TH9-30,0	1TK9-30,0	1KV9-30,0
34,0					1TK9-34,0	



Tool holders	
A	
Shank	Part No.
MK1	1A-MK1
MK2	1A-MK2
MK3	1A-MK3
Ø10	1A-10
Ø12	1A-12
Weldon	1A-W20



Tool holders	
NS and DS Short	
Shank	Part No.
MK2	1NS-MK2
MK3	1NS-MK3
Weldon	1NS-W20
Ø10	1DS-10



Insert for WHV and KV						
Type of insert						
Type of tools D mm	Size	Part No.	Part No.	Radius	Suitable for	SSK
WHV 20,0 - 25,0 KV 20-26	07	TPMT-07U	TPMR-07U	0,4	Universal	20
	07		TPMR-07U	0,4	HARDOX	
	07	TPMT-07SA		0,4	Stainless	
	07	TPMT-07SA		0,4	Aluminium	
WHV 25,5 - 38,0 KV 30,0	10	TPMT-10U		0,4	Universal	22
	10	TPMT-10U		0,4	HARDOX	
	10	TPMT-10SA		0,4	Stainless	
	10	TPMT-10SA		0,4	Aluminium	

• The GRANLUND inserts have special chipbreaker angle for optimum chip control.

T, TH and TK

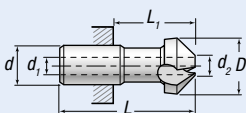

Type	d	d ₁	d _{2min}	L	L ₁
T	14,0	6,0	6,6	48,0	28,0
TH	14,0	6,0	10,0	48,0	28,0
TK	14,0	6,0	4,0	48,0	28,0

KV

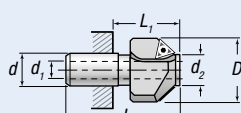

Type	d	d ₁	d _{2min}	L	L ₁
KV (Ø26)	14,0	6,0	13,0	48,0	28,0
KV (Ø30)	14,0	6,0	13,8	48,0	28,0

Important!

• The countersink KV conotip should always be used combined with type R roller pilots. Minimum shank size is MK3.

1MD

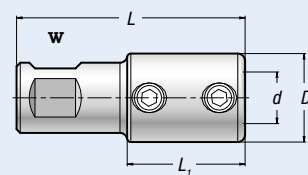

Type	D Tol. g7	d	L	L ₁	Shank
1MD	24	14	62	32	W19,05

Size 1



Tool holders

L
Long

Shank	Part No.
MK2	1L-100-MK2
MK2	1L-150-MK2
MK2	1L-225-MK2
Weldon	1L-250-W20
Ø20	1L-500-20

Tool holders

GS
With through coolant

Shank	Part No.
MK3	1GS-MK3
Weldon	1GS-W25

Tool holders

S
With rotating depthstop

Shank	Part No.
MK2	1S-MK2
Ø10	1S-10

Tool holders

M
Slotted drive

Shank	Part No.
MK3	1M-MK3
W25	1M-W25

Tool holders

MD
Magnetic drills

Shank	Part No.
W19,05	1MD

Important!

- When using carbide cutters – types TH, H and HA – set the axial adjusting screw to contact the shank of inserted pilot or drill.
- Allow a gap between the shoulder of the pilot/drill and the carbide cutting edges to prevent damage by accidental impact.
- The adjusting screw is also used to extend the life of insert drills after regrinding.

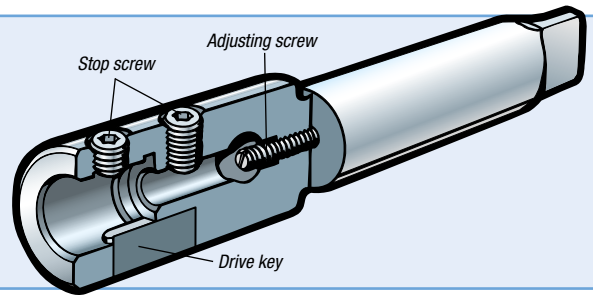

1A

1NS

1DS

1L

Type	D Tol. g7	d	L	L ₁	L ₂	Shank
1A-MK1	24	14	123	62		MK1
1A-MK2	24	14	137	62		MK2
1A-MK3	24	14	160	66		MK3
1A-10	24	14	110	55		Ø10
1A-12	24	14	120	55		Ø12
1A-W20	24	14	110	55		W20
1NS-MK2	24	14	112	37		MK2
1NS-MK3	24	14	130	37		MK3
1NS-W20	24	14	86	32		W20
1DS-10	24	14	62	34		Ø10
1L-100-MK2	26	14	183	108	100	MK2
1L-150-MK2	26	14	233	158	150	MK2
1L-250-W20	24	14	250	55		W20
1L-225-MK2	26	14	308	233	225	MK2
1L-500-20	24	14	500	55		Ø20

1S

1GS

1M

1M-W25

Type	D Tol. g7	d	L	L ₁	L ₂	Shank
1S-MK2	45	14	144	70	20	MK2
1S-10	45	14	128	70	20	Ø10
1GS-MK3	36	14	143	50		MK3
1GS-W25	36	14	105	40		W25
1M-MK3	28	14	166	72		MK3
1M-W25	28	14	122	66		W25
1AS-W20	24	14	86	36		W20

Size 2



Ø mm	Insert drills			Pilots	
	B	LB	BH	F	R
	HSS	HSS	Carbide K20 micrograin	Fixed	Roller
	Tol. h8 Flute 30 mm	Tol. h8 Flute 50 mm	Tol. h8 Flute 30 mm	Tol. c9	Tol. c9
Part No.	Part No.	Part No.	Part No.	Part No.	
10,0				2F-10,0*	2R-10,0*
10,2				2F-10,2*	2R-10,2*
10,5				2F-10,5*	2R-10,5*
11,0	2B-11,0*	2LB-11,0*	2BH-11,0*	2F-11,0*	2R-11,0*
11,5	2B-11,5*	2LB-11,5*	2BH-11,5*	2F-11,5*	2R-11,5*
11,6	2B-11,6*				
12,0	2B-12,0	2LB-12,0	2BH-12,0	2F-12,0	2R-12,0
12,2	2B-12,2				
12,5	2B-12,5	2LB-12,5	2BH-12,5	2F-12,5	2R-12,5
13,0	2B-13,0	2LB-13,0	2BH-13,0	2F-13,0	2R-13,0
13,5	2B-13,5	2LB-13,5	2BH-13,5	2F-13,5	2R-13,5
14,0	2B-14,0	2LB-14,0	2BH-14,0	2F-14,0	2R-14,0
14,5	2B-14,5	2LB-14,5	2BH-14,5	2F-14,5	2R-14,5
15,0	2B-15,0	2LB-15,0	2BH-15,0	2F-15,0	2R-15,0
15,1	2B-15,1				
15,5	2B-15,5	2LB-15,5	2BH-15,5	2F-15,5	2R-15,5
16,0	2B-16,0	2LB-16,0	2BH-16,0	2F-16,0	2R-16,0
16,5	2B-16,5	2LB-16,5	2BH-16,5	2F-16,5	2R-16,5
17,0	2B-17,0	2LB-17,0	2BH-17,0	2F-17,0	2R-17,0
17,5	2B-17,5	2LB-17,5		2F-17,5	2R-17,5
18,0	2B-18,0	2LB-18,0	2BH-18,0	2F-18,0	2R-18,0
18,5	2B-18,5	2LB-18,5		2F-18,5	2R-18,5
19,0	2B-19,0	2LB-19,0	2BH-19,0	2F-19,0	2R-19,0
19,5	2B-19,5			2F-19,5	2R-19,5
20,0	2B-20,0	2LB-20,0	2BH-20,0	2F-20,0	2R-20,0
20,5				2F-20,5	2R-20,5
21,0	2B-21,0	2LB-21,0	2BH-21,0	2F-21,0	2R-21,0
21,5				2F-21,5	2R-21,5
22,0	2B-22,0	2LB-22,0		2F-22,0	2R-22,0
22,5				2F-22,5	2R-22,5
23,0	2B-23,0			2F-23,0	2R-23,0
23,5				2F-23,5	
24,0	2B-24,0			2F-24,0	2R-24,0
24,5				2F-24,5	2R-24,5
25,0	2B-25,0	2LB-25,0		2F-25,0	2R-25,0
25,5				2F-25,5	2R-25,5
26,0				2F-26,0	2R-26,0
26,5				2F-26,5	2R-26,5
27,0				2F-27,0	2R-27,0
27,5				2R-27,5	
28,0				2F-28,0	2R-28,0
29,0				2F-29,0	2R-29,0
30,0				2F-30,0	2R-30,0
30,5				2R-30,5	
31,0				2R-31,0	
32,0				2R-32,0	
33,0				2R-33,0	
34,0				2R-34,0	
35,0				2R-35,0	
36,0				2R-36,0	
37,0				2R-37,0	
38,0				2R-38,0	
39,0				2R-39,0	
40,0				2R-40,0	
42,0				2R-42,0	
44,0				2R-44,0	
45,0				2R-45,0	
46,0				2R-46,0	
48,0				2R-48,0	
50,0				2R-50,0	

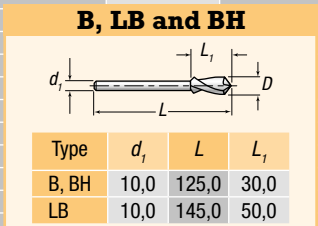

Important!

- When using insert drills, the drill must drill through before the countersink/counterbore starts to cut. Insert drill must not be used in blind holes.

F and R

Type	d ₁	L	L ₁
F, R	10,0	110,0	20,0

*2R < Ø13 mm, L1=14,0 mm

Important!

- When working "dry" type R roller pilots must be lubricated.

Ø mm	Counterbores					
	N	NA	W	H	HA	WHV
	HSS	HSS	HSS	Carbide K40 micrograin	Carbide K10 micrograin	For carbide inserts
	Tol. p8	Tol. p8	Tol. p8	Tol. p8	Tol. p8	Tol. ± 0,1
Part No.	Part No.	Part No.	Part No.	Part No.	Part No.	
16,0	2N-16,0	2NA-16,0	2W-16,0			
16,5	2N-16,5					
17,0	2N-17,0	2NA-17,0				
17,5	2N-17,5					
18,0	2N-18,0	2NA-18,0	2W-18,0	2H-18,0	2HA-18,0	
18,5	2N-18,5					
19,0	2N-19,0	2NA-19,0	2W-19,0			
19,5	2N-19,5	2NA-19,5				
20,0	2N-20,0	2NA-20,0	2W-20,0	2H-20,0	2HA-20,0	
20,5	2N-20,5					
21,0	2N-21,0	2NA-21,0		2H-21,0		
21,5	2N-21,5					
22,0	2N-22,0	2NA-22,0	2W-22,0	2H-22,0	2HA-22,0	
22,5	2N-22,5	2NA-22,5				
23,0	2N-23,0	2NA-23,0	2W-23,0	2H-23,0	2HA-23,0	
23,5	2N-23,5					
24,0	2N-24,0	2NA-24,0	2W-24,0	2H-24,0		
24,5	2N-24,5					
25,0	2N-25,0	2NA-25,0	2W-25,0	2H-25,0	2HA-25,0	
25,5	2N-25,5					
26,0	2N-26,0	2NA-26,0	2W-26,0	2H-26,0	2HA-26,0	
26,5	2N-26,5					
27,0	2N-27,0	2NA-27,0	2W-27,0	2H-27,0		
27,5	2N-27,5					
28,0	2N-28,0	2NA-28,0	2W-28,0	2H-28,0	2HA-28,0	
28,5	2N-28,5					
29,0	2N-29,0	2NA-29,0	2W-29,0	2H-29,0	2HA-29,0	
29,5	2N-29,5					
30,0	2N-30,0	2NA-30,0	2W-30,0	2H-30,0	2HA-30,0	
30,5	2N-30,5					
31,0	2N-31,0	2NA-31,0	2W-31,0	2H-31,0	2HA-31,0	
32,0	2N-32,0	2NA-32,0	2W-32,0	2H-32,0	2HA-32,0	
33,0	2N-33,0	2NA-33,0	2W-33,0	2H-33,0	2HA-33,0	
34,0	2N-34,0	2NA-34,0	2W-34,0	2H-34,0	2HA-34,0	2WHV-34,0
35,0	2N-35,0	2NA-35,0	2W-35,0	2H-35,0	2HA-35,0	2WHV-35,0
36,0	2N-36,0	2NA-36,0	2W-36,0	2H-36,0	2HA-36,0	2WHV-36,0
37,0	2N-37,0	2NA-37,0		2H-37,0	2HA-37,0	2WHV-37,0
38,0	2N-38,0	2NA-38,0	2W-38,0	2H-38,0	2HA-38,0	2WHV-38,0
39,0	2N-39,0	2NA-39,0		2H-39,0		2WHV-39,0
40,0	2N-40,0	2NA-40,0	2W-40,0	2H-40,0	2HA-40,0	2WHV-40,0
41,0	2N-41,0	2NA-41,0		2H-41,0		2WHV-41,0
42,0	2N-42,0	2NA-42,0		2H-42,0	2HA-42,0	2WHV-42,0
43,0	2N-43,0	2NA-43,0		2H-43,0		2WHV-43,0
44,0	2N-44,0	2NA-44,0		2H-44,0	2HA-44,0	2WHV-44,0
45,0	2N-45,0	2NA-45,0		2H-45,0	2HA-45,0	2WHV-45,0
46,0	2N-46,0	2NA-46,0		2H-46,0	2HA-46,0	2WHV-46,0
47,0	2N-47,0				2HA-47,0	2WHV-47,0
48,0	2N-48,0	2NA-48,0		2H-48,0	2HA-48,0	2WHV-48,0
48,0	2N-49,0	2NA-49,0				2WHV-49,0
50,0	2N-50,0*	2NA-50,0*		2H-50,0*	2HA-50,0*	2WHV-50,0**
51,0	2N-51,0*	2NA-51,0*				2WHV-51,0**
52,0	2N-52,0*	2NA-52,0*		2H-52,0*	2HA-52,0*	2WHV-52,0**
53,0	2N-53,0*	2NA-53,0*				2WHV-53,0**
54,0	2N-54,0*	2NA-54,0*				2WHV-54,0**
55,0	2N-55,0*	2NA-55,0*		2H-55,0*	2HA-55,0*	2WHV-55,0**
56,0	2N-56,0*	2NA-56,0*		2H-56,0*	2HA-56,0*	2WHV-56,0**
57,0	2N-57,0*	2NA-57,0*				
58,0	2N-58,0*	2NA-58,0*		2H-58,0*	2HA-58,0*	2WHV-58,0**
60,0	2N-60,0*	2NA-60,0*		2H-60,0*	2HA-60,0*	2WHV-60,0**
62,0	2N-62,0*	2NA-62,0*		2H-62,0*	2HA-62,0*	2WHV-62,0**
64,0	2N-64,0*	2NA-64,0*			2HA-64,0*	2WHV-64,0**
65,0	2N-65,0*	2NA-65,0*		2H-65,0*	2HA-65,0*	2WHV-65,0**
66,0	2N-66,0*	2NA-66,0*		2H-66,0*		
68,0		2NA-68,0*			2HA-68,0*	2WHV-68,0**
70,0	2N-70,0*	2NA-70,0*		2H-70,0*	2HA-70,0*	2WHV-70,0**
72,0	2N-72,0*	2NA-72,0*		2H-72,0*		2WHV-72,0**
74,0		2NA-74,0*			2HA-74,0*	
75,0	2N-75,0*	2NA-75,0*		2H-75,0*	2HA-75,0*	2WHV-75,0**
76,0	2N-76,0*	2NA-76,0*				
78,0		2NA-78,0*				
80,0	2N-80,0*	2NA-80,0*				
82,0	2N-82,0*					
84,0		2NA-84,0*				
85,0	2N-85,0*	2NA-85,0*				

* Use holders type M.
** Recommended minimum shank size MT3.



Ø mm	Countersinks						
	T	T	T	TH	TK	KV	KV
	HSS Tol. x9 60° Part No.	HSS Tol. x9 80° Part No.	HSS Tol. x9 90° Part No.	Carbide K 10 Tol. x9 90° Part No.	HSS Tol. x9 90° Part No.	For carbide inserts Tol. + 0,2-0 60° Part No.	For carbide inserts Tol. + 0,2-0 90° Part No.
20,0	2T6-20,0		2T9-20,0				
22,0			2T9-22,0				
25,0	2T6-25,0		2T9-25,0				
28,0			2T9-28,0				
30,0	2T6-30,0	2T8-30,0	2T9-30,0		2TK9-30,0		
31,0			2T9-31,0				
32,0							2KV9-32,0
32,4			2T9-32,4				
34,0			2T9-34,0				
35,0	2T6-35,0		2T9-35,0				2KV9-35,0
36,0							
37,0			2T9-37,0		2TK9-37,0		
38,0							2KV9-38,0
39,0							
40,0	2T6-40,0	2T8-40,0	2T9-40,0	2TH9-40,0	2TK9-40,0		2KV9-40,0
41,0						2KV6-41,0	
42,0							
43,0							
44,0							
45,0			2T9-45,0		2TK9-45,0		2KV9-45,0
46,0							
47,0							
48,0							
48,0							
50,0	2T6-50,0		2T9-50,0	2TH9-50,0	2TK9-50,0	2KV6-50,0	2KV9-50,0
51,0							
52,0							
53,0							
55,0							
56,0							
58,0							
60,0	2T6-60,0		2T9-60,0	2TH9-60,0	2TK9-60,0	2KV6-60,0	2KV9-60,0
62,0							
64,0							
65,0							
68,0							
70,0							
72,0							
75,0			2T9-75,0		2TK9-75,0		
85,0			2T9-85,0				

2A

2NS

2L

Type	D Tol. g7	d	L	L ₁	L ₂	Shank
2A-MK2	36	22	160	85		MK2
2A-MK3	36	22	180	87		MK3
2A-MK4	36	22	206	89		MK4
2A-MK5	36	22	240	91		MK5
2A-W20	36	22	140	71		W20
2NS-MK3	36	22	145	51		MK3
2NS-W25	36	22	105	45		W25
2L-L250-MK3	40	22	355	261	250	MK3
2L-L250-W25	40	22	250	75		Weldon
2L-500-32	36	22	500	51		Ø32

T, TH and TK

Type	d	d ₁	d _{2min}	L	L ₁
T (-Ø50)	22,0	10,0	10,8	61,0	33,0
T (Ø60)	22,0	10,0	22,0	61,0	33,0
T (-Ø70)	22,0	10,0	37,0	61,0	33,0
T (Ø85)	22,0	10,0	44,0	61,0	33,0
TH (Ø40)	22,0	10,0	14,0	61,0	33,0
TH (Ø60)	22,0	10,0	14,0	61,0	33,0
TH (Ø80)	22,0	10,0	22,0	61,0	33,0
TK (Ø30,37)	22,0		5,0	61,0	33,0
TK (Ø40,45)	22,0		8,0	61,0	33,0
TK (Ø50-)	22,0		10,0	61,5	33,0
TK (Ø60)	22,0		13,0	65,0	33,0
TK (-Ø75)	22,0		25,0	67,0	33,0

Important!
• Countersinks TH, TK, T Ø 50 are made with a driving lip. These sizes should be used in the appropriate type M holder.

KV

Type	d	d ₁	d _{2min}	L	L ₁
KV (Ø32)	22,0	10,0	17,0	61,0	33,0
KV (Ø35)	22,0	10,0	18,0	61,0	33,0
KV (Ø38)	22,0	10,0	18,0	61,0	33,0
KV (Ø40)	22,0	10,0	18,0	61,0	33,0
KV (Ø41)	22,0	10,0	24,0	61,0	33,0
KV9 (Ø50,60)	22,0	10,0	22,0	61,0	33,0
KV6 (Ø50)	22,0	10,0	29,0	61,0	33,0
KV6 (Ø60)	22,0	10,0	33,0	61,0	33,0

Important!
• The countersink KV conotip should always be used combined with type R roller pilots. Minimum shank size is MK3.

N, NA and W H and HA

Important!
• Counterbores N, NA, H and HA Ø 50 mm and larger are all made with a driving lip. These sizes should be used in the appropriate type M toolholder.

Type	d	d ₁	d _{2min}	L	L ₁
N, NA, W	22,0	10,0		61,0	33,0
H, HA, WH	22,0	10,0	12,0	61,0	33,0

WHV

Important!
• The counterbore WHV Rotatip should always be used combined with type R roller pilots. The shank of the holder must not be smaller than MT3.

Type	d	d ₁	d _{2min}	L	L ₁
WHV 34-45	22,0	10,0	14,8*	61,0	33,0
WHV 46-75	22,0	10,0	15,5*	61,0	33,0
WHV 75	22,0	10,0	17,0*	61,0	33,0

Size 2



Tool holders

A

Shank	Part No.
MK2	2A-MK2
MK3	2A-MK3
MK4	2A-MK4
MK5	2A-MK5
Weldon	2A-W20

Tool holders

NS
Short

Shank	Part No.
MK3	2NS-MK3
Weldon	2NS-W25

Tool holders

L
Long

Shank	Part No.
MK3	2L-250-MK3
Weldon	2L-250-W25
Ø32	2L-500-32

Tool holders

GS
With through coolant

Shank	Part No.
MK3	2GS-MK3
Weldon	2GS-W25

Tool holders

S
With rotating depthstop

Shank	Part No.
MK3	2S-MK3

Insert for WHV and KV

Type of tools D mm	Size	Part No.	Part No.	Radius	Suitable for	SSK
KV 32,0-41,0	10	TPMT-10U		0,4	Universal	22
	10	TPMR-10U		0,4	HARDOX	
	10	TPMT-10SA		0,4	Stainless	
	10	TPMT-10SA		0,4	Aluminium	
WHV 34,0-45,0 KV 45	12	TPMT-12U		0,8	Universal	25
	12	TPMT-12U		0,8	HARDOX	
	12	TPMT-12M		0,8	Stainless	
WHV 46,0- KV 50-	12	TPMT-12K		0,8	Aluminium	40
	17	TPMT-17U		0,8	Universal	
	17	TPMT-17U		0,8	HARDOX	
	17	TPMT-17M		0,8	Stainless	
	17	TPMT-17K		0,8	Aluminium	

• The GRANLUND inserts have special chipbreaker angle for optimum chip control.

Tool holders

M
Slotted drive

Shank	Part No.
MK3	2M-MK3
MK4	2M-MK4
W32	2M-W32

Tool holders

MD
Magnetic drills

Shank	Part No.
W19,05	2MD

2S

2GS

2M

2M-W32

Type	D Tol. g7	d	L	L ₁	L ₂	Shank
2S-MK3	63	22	187	94	25	MK3
2GS-MK3	44	22	154	61		MK3
2GS-W25	44	22	115	51		W25
2M-MK3	48	22	187	93		MK3
2M-MK4	48	22	212	95		MK4
2M-W32	48	22	148	88		W32

2MD

Type	D Tol. g7	d	L	L ₁	Shank
2MD	36	22	80	45	W19,05

Important!

- When using carbide cutters – types TH, H and HA – set the axial adjusting screw to contact the shank of inserted pilot or drill.
- Allow a gap between the shoulder of the pilot/drill and the carbide cutting edges to prevent damage by accidental impact.
- The adjusting screw is also used to extend the life of insert drills after regrinding.

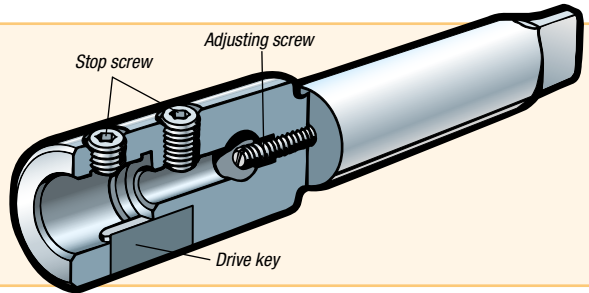

Counterbore Sets



Set		
Part No. 0P / M4-M8		
Counterbores type N, Ø mm	Pilots type F, Ø mm	Tool holders
8,0	4,5	0A-MK2
9,0	5,0	
10,0	5,5	
11,0	6,0	
12,0	6,5	
13,0	6,6	
14,0	7,0	
15,0	7,5	
	8,0	
	8,5	
	9,0	
	10,0	



Set		
Part No. 0D / M4-M12		
Counterbores type N, Ø mm	Pilots type F, Ø mm	Tool holders
8,0	4,3	0A-MK2
10,0	4,5	
11,0	5,3	
15,0	5,5	
18,0	6,4	
20,0	6,6	
	8,4	
	9,0	
	10,5	
	11,0	
	13,0	
	13,5	

According to DIN 74, Form 1, 2, 3.



Set		
Part No. 1P / M8-M14		
Counterbores type N, Ø mm	Pilots type F, Ø mm	Tool holders
14,0	8,0	1A-MK2
15,0	8,5	
16,0	9,0	
18,0	9,5	
20,0	10,0	
22,0	10,5	
24,0	11,0	
	11,5	
	12,0	
	12,5	
	13,0	
	13,5	
	14,0	
	14,5	
	15,0	
	15,5	
	16,0	



Set		
Part No. 1D / M8-M16		
Counterbores type N, Ø mm	Pilots type F, Ø mm	Tool holders
15,0	8,4	1A-MK2
18,0	9,0	
20,0	10,5	
24,0	11,0	
26,0	13,0	
	13,5	
	15,0	
	15,5	
	17,0	
	17,5	

According to DIN 74, Form 1, 2, 3

Important!

* Counterbore Set 01P can be found on page 9 in this catalog.



Set		
Part No. 2P / M14-M24		
Counterbores type N, Ø mm	Pilots type F, Ø mm	Tool holders
24,0	13,0	2A-MK3
26,0	14,0	
28,0	15,0	
30,0	16,0	
32,0	17,0	
33,0	18,0	
34,0	19,0	
36,0	20,0	
40,0	21,0	
	22,0	
	23,0	
	24,0	
	25,0	
	26,0	



Set		
Part No. 2D / M14-M24		
Counterbores type N, Ø mm	Pilots type F, Ø mm	Tool holders
24,0	15,0	2A-MK3
26,0	15,5	
30,0	17,0	
33,0	17,5	
36,0	19,0	
40,0	20,0	
	21,0	
	22,0	
	23,0	
	24,0	
	25,0	
	26,0	

According to DIN 74, Form 1, 2, 3.

CNC Tools, sizes and dimensions

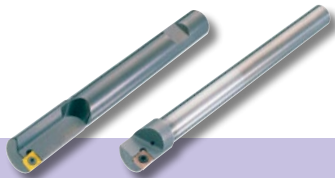

FA, FAH Boring Tool							
D mm	Part No.	d ₁	L	L ₁	d	No. of inserts/ Size	
9,8	FA-09,8	9,3	85	20	8	1x06	
10,8	FA-10,8	10,3	95	20	10	1x06	
11,8	FA-11,8	11,3	100	25	10	1x06	
12,8	FA-12,8	12,3	105	30	10	1x06	
13,8	FA-13,8	13,3	110	35	10	1x06	
14,8	FA-14,8	14,3	120	30	12	1x06	
15,8	FA-15,8	15,3	125	35	12	1x06	
16,8	FA-16,8	15,8	133	30	16	1x06	
17,8	FA-17,8	16,8	138	35	16	1x06	
18,8	FA-18,8	17,8	143	40	16	1x06	
19,8	FA-19,8	18,8	148	45	16	1x06	
20,8	FA-20,8	19,8	153	50	16	1x06	
21,8	FA-21,8	20,8	158	55	16	1x06	
22,8	FA-22,8	21,0	165	41	20	1x06	
23,8	FA-23,8	22,0	170	46	20	1x06	
24,8	FA-24,8	23,0	175	51	20	1x06	
25,8	FA-25,8	24,0	180	56	20	1x06	
26,8	FA-26,8	25,0	185	41	20	1x06	
27,8	FA-27,8	26,0	190	46	20	1x06	
28,8	FA-28,8	27,0	195	51	20	1x06	
29,8	FA-29,8	28,0	195	51	20	1x06	
30,8	FA-30,8	29,0	195	51	20	1x06	
31,8	FA-31,8	30,0	195	51	20	1x06	
9,8	FAH-09,8	9,3	105	20	8	1x06	
10,8	FAH-10,8	10,3	105	20	8	1x06	
11,8	FAH-11,8	11,3	125	20	10	1x06	
12,8	FAH-12,8	12,3	125	20	10	1x06	
13,8	FAH-13,8	13,3	125	20	10	1x06	
14,8	FAH-14,8	14,3	140	20	12	1x06	
15,8	FAH-15,8	15,3	140	20	12	1x06	
16,8	FAH-16,8	16,3	150	30	12	1x06	
17,8	FAH-17,8	16,8	160	40	16	1x06	
18,8	FAH-18,8	17,8	160	40	16	1x06	
19,8	FAH-19,8	18,8	180	40	16	1x06	
20,8	FAH-20,8	19,8	180	40	16	1x06	
21,8	FAH-21,8	20,8	180	40	16	1x06	
22,8	FAH-22,8	21,0	195	40	20	1x06	
23,8	FAH-23,8	22,0	195	40	20	1x06	
24,8	FAH-24,8	23,0	210	40	20	1x06	
25,8	FAH-25,8	24,0	210	40	20	1x06	
26,8	FAH-26,8	25,0	210	40	20	1x06	
27,8	FAH-27,8	26,0	225	40	20	1x06	
28,8	FAH-28,8	27,0	225	40	20	1x06	
29,8	FAH-29,8	28,0	225	40	20	1x06	
30,8	FAH-30,8	29,0	225	40	20	1x06	
31,8	FAH-31,8	30,0	225	40	20	1x06	



FAE Boring and Chamfering Tool							
D mm	Part No.	d ₁	L	L ₁	F _{max}	d	No. of inserts/ Size
9,8	FAE-09,8	9,3	105	20	0,6	8	1x06
10,8	FAE-10,8	10,3	105	20	1,1	8	1x06
11,8	FAE-11,8	11,3	125	20	0,6	10	1x06
12,8	FAE-12,8	12,3	125	20	1,1	10	1x06
13,8	FAE-13,8	13,3	125	20	1,6	10	1x06
14,8	FAE-14,8	14,3	140	20	1,1	12	1x06
15,8	FAE-15,8	15,3	140	20	1,6	12	1x06
16,8	FAE-16,8	16,3	150	30	2,1	12	1x06
17,8	FAE-17,8	16,8	160	40	0,6	16	1x06
18,8	FAE-18,8	17,8	160	40	1,1	16	1x06
19,8	FAE-19,8	18,8	180	40	1,6	16	1x06
20,8	FAE-20,8	19,8	180	40	2,1	16	1x06
21,8	FAE-21,8	20,8	180	40	2,1	16	1x06
22,8	FAE-22,8	21,0	195	40	1,1	20	1x06
23,8	FAE-23,8	22,0	195	40	1,6	20	1x06
24,8	FAE-24,8	23,0	210	40	2,1	20	1x06
25,8	FAE-25,8	24,0	210	40	2,1	20	1x06
26,8	FAE-26,8	25,0	210	40	2,1	20	1x06
27,8	FAE-27,8	26,0	225	40	2,1	20	1x06
28,8	FAE-28,8	27,0	225	40	2,1	20	1x06
29,8	FAE-29,8	28,0	225	40	2,1	20	1x06
30,8	FAE-30,8	29,0	225	40	2,1	20	1x06
31,8	FAE-31,8	30,0	225	40	2,1	20	1x06



FM Counterbore							
D mm	Part No.	d ₁	L	L ₁	L ₂	Weldon	No. of inserts/ Size
10,0	FM-10	4,0	80	23	45	12	1x06
11,0	FM-11	4,0	80	23	45	12	1x06
12,0	FM-12	4,0	80	26	45	12	1x06
13,0	FM-13	5,0	80	26	45	12	1x06
14,0	FM-14	5,0	80	26	45	12	1x06
15,0	FM-15	5,0	80	26	45	12	1x06
16,0	FM-16	5,0	90	31	48	16	1x06
17,0	FM-17	6,0	90	31	48	16	1x06
18,0	FM-18	8,0	90	31	48	16	1x06
19,0	FM-19	8,0	90	31	48	16	1x06
20,0	FM-20	5,0	100	36	50	20	1x09
21,0	FM-21	5,0	100	36	50	20	1x09
22,0	FM-22	6,0	100	36	50	20	1x09
23,0	FM-23	6,0	100	36	50	20	1x09
24,0	FM-24	8,0	100	36	50	20	1x09
25,0	FM-25	8,0	120	43	56	25	1x09
26,0	FM-26	10,0	120	43	56	25	1x09



ES Collet						
D mm	Part No.	d	L	L ₁	D ₁	h
25,0	ES-25-08	8	61	56	29	23
25,0	ES-25-10	10	61	56	29	23
25,0	ES-25-12	12	61	56	29	23
25,0	ES-25-16	16	61	56	29	23
32,0	ES-32-08	8	65	60	36	30
32,0	ES-32-10	10	65	60	36	30
32,0	ES-32-12	12	65	60	36	30
32,0	ES-32-16	16	65	60	36	30
32,0	ES-32-20	20	65	60	36	30
32,0	ES-32-25	25	65	60	36	30

With ES to FA, FAH and FAE the diameter (D) can be adjusted ± 0,5 mm.

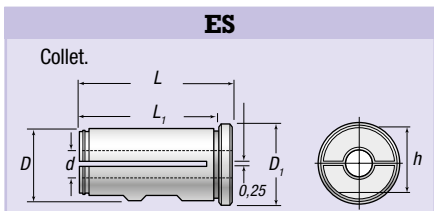
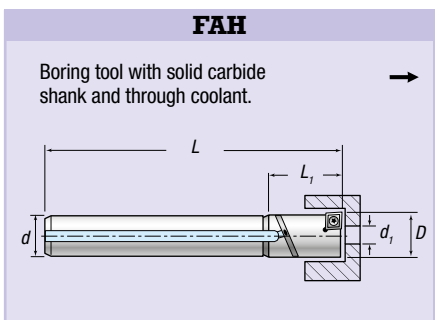
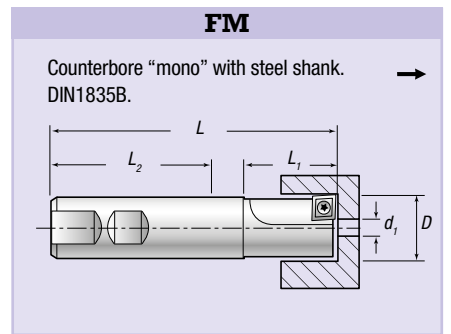
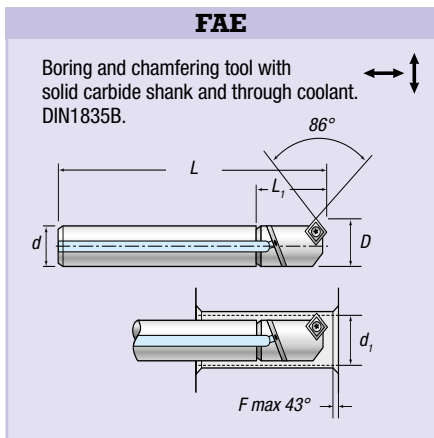
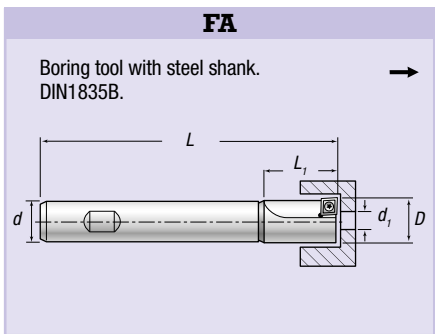



FMK Counterbore							
D mm	Part No.	d ₁	L	L ₁	L ₂	Weldon	No. of inserts/ Size
10,0	FMK-10	4,0	80	23	45,0	12	1x06
11,0	FMK-11	4,0	80	23	45,0	12	1x06
12,0	FMK-12	4,0	80	26	45,0	12	1x06
13,0	FMK-13	5,0	80	26	45,0	12	1x06
14,0	FMK-14	5,0	80	26	45,0	12	1x06
15,0	FMK-15	5,0	80	26	45,0	12	1x06
16,0	FMK-16	5,0	90	31	48,0	16	1x06
17,0	FMK-17	6,0	90	31	48,0	16	1x06
18,0	FMK-18	8,0	90	31	48,0	16	1x06
19,0	FMK-19	8,0	90	31	48,0	16	1x06
20,0	FMK-20	5,0	100	36	50,0	20	1x09
21,0	FMK-21	5,0	100	36	50,0	20	1x09
22,0	FMK-22	6,0	100	36	50,0	20	1x09
23,0	FMK-23	6,0	100	36	50,0	20	1x09
24,0	FMK-24	8,0	120	36	50,0	20	1x09
25,0	FMK-25	8,0	120	43	56,0	20	1x09
26,0	FMK-26	10,0	120	43	56,0	25	1x09
27,0	FMK-27	10,0	120	43	56,0	25	1x09
28,0	FMK-28	12,0	120	43	56,0	25	1x09
29,0	FMK-29	12,0	120	43	56,0	25	1x09
30,0	FMK-30	14,0	120	43	56,0	25	1x09
31,0	FMK-31	14,0	120	43	56,0	25	1x09
32,0	FMK-32	16,0	120	43	56,0	25	1x09
33,0	FMK-33	16,0	120	43	56,0	25	1x09



FMU Counterbore							
D mm	Part No.	d ₁	L	L ₁	L ₂	Weldon	No. of inserts/ Size
15,0	FMU-15	4,0	100	40	30,0	20	2x06
18,0	FMU-18	6,0	100	40	30,0	20	2x06
20,0	FMU-20	8,0	100	40	30,0	20	2x06
22,0	FMU-22	10,0	100	40	30,0	20	2x06
24,0	FMU-24	6,0	136	68	50,0	25	2x09
26,0	FMU-26	8,0	136	68	50,0	25	2x09
28,0	FMU-28	10,0	136	68	50,0	25	2x09
30,0	FMU-30	12,0	136	66	50,0	32	3x09
33,0	FMU-33	15,0	136	66	50,0	32	3x09
36,0	FMU-36	18,0	136	66	50,0	32	3x09
40,0	FMU-40	16,0	136	66	50,0	32	3x12
43,0	FMU-43	19,0	136	66	50,0	32	3x12
48,0	FMU-48	24,0	146	81	60,0	32	3x12
53,0	FMU-53	29,0	146	81	60,0	32	3x12
57,0	FMU-57	33,0	146	81	60,0	32	3x12



PK 15°, 30°, 45°, 60°, 75° Chamfer and face milling tool							
D mm	Part No.	d ₁	L	L ₁	L ₂	Weldon	No. of inserts/ Size
19,0	PK15-19	16,0	90	19	6,0	16	2x06
40,0	PK15-40	34,0	120	30	11,0	25	2x12
19,0	PK30-19	13,0	90	19	5,0	16	2x06
40,0	PK30-40	28,0	120	30	10,0	25	2x12
13,0	PK45-13	6,0	80	12	4,0	10	1x06
19,0	PK45-19	11,0	90	19	4,0	16	2x06
26,0	PK45-26	15,0	100	26	6,0	20	2x09
40,0	PK45-40	25,0	120	30	8,0	25	2x12
32,0	PK60-32	17,5	100	26	4,0	20	2x09
32,0	PK75-32	15,5	100	26	2,0	20	2x09



FF 2-flute chamfer tool							
D mm	Part No.	d ₁	L	L ₁	L ₂	Weldon	B No. of inserts/ Size
30,0	FF-30	20,0	120	20	5,0	20	20 2x09
40,0	FF-40	30,0	150	20	5,0	25	25 2x09

FMK

Counterbore "mono" with steel shank and through coolant. DIN1835B. →

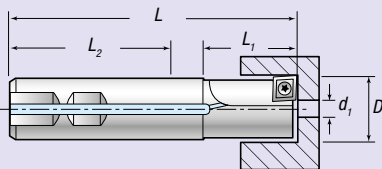

FMU

Counterbore "multi" with steel shank and through coolant. DIN1835B. →

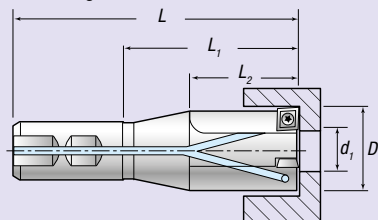

PK

Chamfer and face milling tool. ↻↑

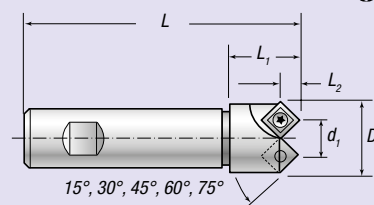

FF

2-flute chamfer tool 2x45°. DIN1835B. ↻↑

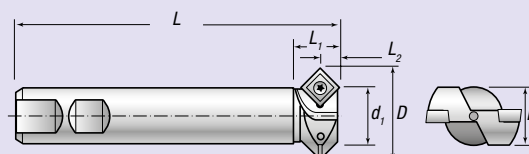



FM - FMK - FMU - PK ● = Excellent ○ = Good m/min fz=0,05-0,15												
Part No.	Working piece				Free cutting steel	Tool steels alloyed	High alloyed steel	Stainless steels	High temp resistant steel and alloys	Titanium alloys	Grey cast iron	Aluminium
	Size	Chip breaker	Grade	Radius	HB 175-225 <800N/mm	HB 200-300 <1000N/mm	HB 200-300 <1000N/mm	HB 175-245 <700N/mm	HB 200-400 <1200N/mm	HB 215-500 <1000N/mm	HB 175-225 <800N/mm	HB <160
MPHT-N12-D	06	N12	DX6	0,2	● 90-140	● 90-140	● 50-100	● 70-120				
MPHT-N12-P	06	N12	PMK92*	0,2	● 160-300	● 140-220	● 90-150	● 50-180				
MPHT-N13-C	06	N13	CH1	0,2						○ 40-60	● 160-200	● 300-1000
MPHT-N13-K	06	N13	KM22*	0,2					○ 15-70	○ 40-70	● 180-300	● 300-600
MPHT-N14-D	06	N14	DX6	0,2	● 90-140			● 70-120	○ 15-20	○ 40-60		
MPHT-N14-P	06	N14	PMK92*	0,2	● 160-300	● 140-220	● 90-150	● 90-180				
MPHT-N14-P	06	N15	CT50**	0,2	● 250-400	● 200-350	● 180-250	● 150-240	○ 15-70		● 250-400	● 300-1000
MPMT-N12-C	06	N12	CH1	0,4						○ 40-60	● 160-200	● 300-1000
MPMT-N12-D	06	N12	DX6	0,4	● 90-140	● 80-140	● 50-100	● 70-120				
MPMT-N12-P	06	N12	PMK92*	0,4	● 160-300	● 140-220	● 90-150	● 90-180				
MPMT-N12-K	06	N12	KM22*	0,4					○ 15-70	○ 40-70	● 180-300	
MCHT-N12-D	09	N12	DX6	0,4	● 90-140							
MCHT-N12-P	09	N12	PMK92*	0,4	● 160-300	● 140-220	● 90-150	● 90-180				
MCHT-N13-C	09	N13	CH1	0,4						○ 40-60	● 160-300	● 300-1000
MCHT-N13-K	09	N13	KM22*	0,4				● 150-300	○ 15-70	○ 40-70		● 300-600
MCHT-N14-D	09	N14	DX6	0,4	● 90-140	● 90-140	● 50-100	● 70-120				
MCHT-N14-P	09	N14	PMK92*	0,4	● 160-300	● 140-220	● 90-150	● 90-180				
MCHW-N15-C	09	N15	CT50**	0,4	● 250-400	● 200-350	● 180-250	● 150-240			● 250-400	
MCMT-N12-C	09	N12	CH1	0,8					○ 15-70	○ 40-70	● 160-200	● 300-1000
MCMT-N12-P	09	N12	PMK92*	0,8	● 160-300	● 140-220	● 90-150	● 90-180				
MCMT-N12-K	09	N12	KM22*	0,8					○ 15-70	○ 40-70	● 180-300	
MBHT-N12-P	12	N12	PMK92*	0,4	● 160-300	● 140-220	● 90-150	● 90-180	○ 20-60			
MBHT-N13-C	12	N13	CH1	0,4						○ 40-60	● 160-200	● 300-1000
MBHT-N13-K	12	N13	KM22*	0,4				● 150-300	○ 15-70	○ 40-70		● 300-600
MBHT-N14-P	12	N14	PMK92*	0,4	● 160-300	● 140-220	● 90-150	● 90-180				
MBMT-N12-D	12	N12	DX6	0,8	● 90-140	● 90-140	● 50-100	● 70-120				
MBMT-N12-P	12	N12	PMK92*	0,8	● 160-300	● 140-220	● 90-150	● 90-180	○ 20-60			

*=(TiAlN), **=(Cermet)

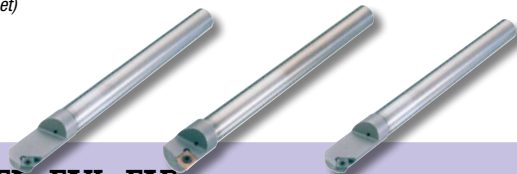

FA - FAH - FAE ● = Excellent ○ = Good m/min fz=0,03-0,1												
Part No.	Working piece				Free cutting steel	Tool steels alloyed	High alloyed steel	Stainless steels	High temp resistant steel and alloys	Titanium alloys	Grey cast iron	Aluminium
	Size	Chip breaker	Grade	Radius	HB 175-225 <800N/mm	HB 200-300 <1000N/mm	HB 200-300 <1000N/mm	HB 215-500 <1000N/mm	HB 175-245 <700N/mm	HB 200-400 <1200N/mm	HB 175-225 <800N/mm	HB <160
MPHT-N12-D	06	N12	DX6	0,2	● 90-140	● 90-140	● 50-100	● 70-120				
MPHT-N12-P	06	N12	PMK92*	0,2	● 160-300	● 140-220	● 90-150	● 50-180				
MPHT-N13-C	06	N13	CH1	0,2					○ 15-60	○ 40-60	● 160-200	● 150-190
MPHT-N13-K	06	N13	KM22*	0,2					○ 15-70	○ 40-70	● 180-300	● 170-270
MPHT-N14-D	06	N14	DX6	0,2	● 100-150	● 80-180	● 50-100	● 70-120				
MPHT-N14-P	06	N14	PMK92*	0,2	● 180-300	● 160-300	● 90-150	● 80-160				
MPHW-N15-C	06	N15	CT50**	0,2	● 250-400	● 250-400	● 180-250			○ 15-70	● 250-400	● 300-1000
MPHX-R16-C	06	R16	CT50**	0,4	● 00-500	● 250-400	● 180-250			○ 15-70	● 250-400	● 300-1000

*=(TiAlN), **=(Cermet)



FF ● = Excellent ○ = Good m/min fz=0,05-0,3												
Part No.	Working piece				Free cutting steel	Tool steels alloyed	High alloyed steel	Stainless steels	High temp resistant steel and alloys	Titanium alloys	Grey cast iron	Aluminium
	Size	Chip breaker	Grade	Radius	HB 175-225 <800N/mm	HB 200-300 <1000N/mm	HB 200-300 <1000N/mm	HB 215-500 <1000N/mm	HB 175-245 <700N/mm	HB 200-400 <1200N/mm	HB 175-225 <800N/mm	HB <160
SDHT-N17-C	09	N17	CH1						○ 15-60		● 160-200	● 300-1000
SDLT-N19-P	09	N19	PMK63***		● 150-250	● 200-250	● 90-180	○ 90-150	○ 40-60		● 100-200	

***=(TiN)

06 = Screw SSK-06 M2,5x4,5 Torx TN-8. 09 = Screw SSK-09 M4x7,5 Torx TN-15. 12 = Screw SSK-12 M4x9,5 Torx TN-15. Screw only FF SSK-08 M3,5x8,5 Torx TN-15.

Countersinks Type 100, with cylindrical shanks



Ø mm	100T				100TT			100TA		
	HSS				HSS TIN			HSS ALDURA PRO		
	Tol.x9 60° Part No.	Tol.x9 80° Part No.	Tol.x9 90° Part No.	Tol.x9 120° Part No.	Tol.x9 60° Part No.	Tol.x9 80° Part No.	Tol.x9 90° Part No.	Tol.x9 60° Part No.	Tol.x9 80° Part No.	Tol.x9 90° Part No.
4,3			100T9-04,3							
5,0			100T9-05,0							
6,0			100T9-06,0				100TT9-06,0			100TA9-06,0
6,3			100T9-06,3				100TT9-06,3			100TA9-06,3
6,5		100T8-06,5	100T9-06,5							
7,0			100T9-07,0							
7,3			100T9-07,3							
8,0	100T6-08,0	100T8-08,0	100T9-08,0				100TT9-08,0			100TA9-08,0
8,3			100T9-08,3				100TT9-08,3			100TA9-08,3
8,6			100T9-08,6							
9,4			100T9-09,4							
10,0	100T6-10,0	100T8-10,0	100T9-10,0		100TT6-10,0	100TT8-10,0	100TT9-10,0	100TA6-10,0	100TA8-10,0	100TA9-10,0
10,4		100T8-10,4	100T9-10,4	100T12-10,4			100TT9-10,4			100TA9-10,4
11,5			100T9-11,5							
12,0	100T6-12,0	100T8-12,0	100T9-12,0		100TT6-12,0		100TT9-12,0	100TA6-12,0		100TA9-12,0
12,4		100T8-12,4	100T9-12,4	100T12-12,4			100TT9-12,4			100TA9-12,4
13,4			100T9-13,4							
15,0			100T9-15,0				100TT9-15,0			100TA9-15,0
16,0	100T6-16,0	100T8-16,0	100T9-16,0		100TT6-16,0		100TT9-16,0	100TA6-16,0		100TA9-16,0
16,4			100T9-16,4							
16,5			100T9-16,5	100T12-16,5			100TT9-16,5			100TA9-16,5
18,0			100T9-18,0							
19,0			100T9-19,0							
20,0	100T6-20,0	100T8-20,0	100T9-20,0		100TT6-20,0	100TT8-20,0	100TT9-20,0	100TA6-20,0	100TA8-20,0	100TA9-20,0
20,5			100T9-20,5	100T12-20,5			100TT9-20,5			100TA9-20,5
22,0			100T9-22,0							
23,0			100T9-23,0							
25,0	100T6-25,0	100T8-25,0	100T9-25,0	100T12-25,0	100TT6-25,0	100TT8-25,0	100TT9-25,0	100TA6-25,0	100TA8-25,0	100TA9-25,0
26,0			100T9-26,0							
28,0			100T9-28,0							
30,0	100T6-30,0	100T8-30,0	100T9-30,0		100TT6-30,0	100TT8-30,0	100TT9-30,0	100TA6-30,0	100TA8-30,0	100TA9-30,0
31,0			100T9-31,0	100T12-31,0						
34,0			100T9-34,0							
35,0			100T9-35,0				100TT9-35,0			100TA9-35,0
37,0			100T9-37,0							
40,0	100T6-40,0	100T8-40,0	100T9-40,0				100TT9-40,0			100TA9-40,0

Dimension table

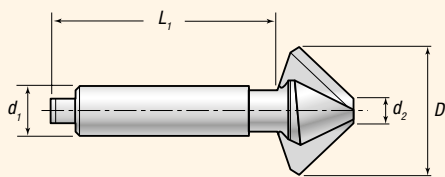

Type 100 60°, 80°, 90°	D x9	d ₁	d ₂	L ₁
T, TT, TA	4,3 - 8,3	6,0	1,5	40
TR, TRHL	8,6 - 13,4	6,0	2,0	40
THS	15,0 - 19,0	10,0*	3,0	45
	20,0 - 31,0	10,0*	4,0	45
	34,0 - 40,0	16,0	8,0	50
100TL	12,0	10,0*	2,0	104
	16,0	10,0*	3,0	106
	20,0 - 30,0	10,0*	4,0	106
100TH	12,0 - 15,0	6,0	4,0	40
	16,0 - 30,0	10,0*	4,0	45
	40,0	16,0	8,0	50
100E	8,0 - 20,0	6,0	1,0	30
	25,0 - 30,0	10,0*	2,0	45
100T12	10,4 - 12,4	6,0	2,0	48
	16,5 - 25,0	10,0	2,0	48
	31,0	12,0	2,5	50

* Cylindrical shank with 3 facets.

Dim	P	M	K	N
Vc	15 - 27	8 - 20	20 - 50	25 - 75
4,3 - 9,4	0,05 - 0,08	0,05 - 0,08		0,05 - 0,09
10,0 - 15,0	0,06 - 0,14	0,06 - 0,14		0,06 - 0,14
16 - 23	0,10 - 0,25	0,10 - 0,20	0,05 - 0,30	0,15 - 0,28
25 - 40	0,20 - 0,30	0,15 - 0,30	0,05 - 0,30	0,15 - 0,30

mm/rev

Countersinks Type 100, with cylindrical shanks



	100TR for Stainless steel	100TRHL for Stainless steel	100TH		100TL Extra long	100E Single flute	100TG Hand deburring tool
	HSS	HSS HARDLUBE	Carbide K10	Carbide K10	HSS	HSS	HSS
	Tol.x9 90°	Tol.x9 90°	Tol.x9 60°	Tol.x9 90°	Tol.x9 90°	Tol.x9 90°	Tol.x9 90°
Ø mm	Part No.	Part No.	Part No.	Part No.	Part No.	Part No.	Part No.
6,3							
8,0	100TR9-08,0	100TRHL9-08,0				100E9-08,0	
8,3	100TR9-08,3	100TRHL9-08,3					
10,0	100TR9-10,0	100TRHL9-10,0				100E9-10,0	
10,4	100TR9-10,4	100TRHL9-10,4					
12,0	100TR9-12,0	100TRHL9-12,0		100TH9-12,0	100TL9-12,0	100E9-12,0	100TG9-12,0
12,4	100TR9-12,4	100TRHL9-12,4					
15,0	100TR9-15,0	100TRHL9-15,0					
16,0	100TR9-16,0	100TRHL9-16,0	100TH6-16,0	100TH9-16,0	100TL9-16,0	100E9-16,0	
16,5	100TR9-16,5	100TRHL9-16,5					
20,0	100TR9-20,0	100TRHL9-20,0	100TH6-20,0	100TH9-20,0	100TL9-20,0	100E9-20,0	100TG9-20,0
20,5	100TR9-20,5	100TRHL9-20,5					
25,0	100TR9-25,0	100TRHL9-25,0	100TH6-25,0	100TH9-25,0	100TL9-25,0	100E9-25,0	
30,0	100TR9-30,0	100TRHL9-30,0	100TH6-30,0	100TH9-30,0	100TL9-30,0	100E9-30,0	100TG9-30,0
35,0	100TR9-35,0	100TRHL9-35,0					
40,0	100TR9-40,0	100TRHL9-40,0		100TH9-40,0			100TG9-40,0



FV 90°, Chamfer and face milling tool

D mm	Part No.	Weldon Shank mm	d _{min} mm	L mm	Chamfers maximum depth mm	No. of inserts
12,0	FV9-12,0	16	6,0	90	5,0	1
12,4	FV9-12,4	16	6,0	90	5,0	1
16,0	FV9-16,0	16	8,0	90	7,5	1
16,5	FV9-16,5	16	8,0	90	7,5	1
20,0	FV9-20,0	20	8,5	100	10,0	2
20,5	FV9-20,5	20	8,5	100	10,0	2
25,0	FV9-25,0	20	13,0	100	12,0	2
30,0	FV9-30,0	20	18,0	100	12,0	2



Inserts for FV

Type of insert	Size		Part No.	Part No.	Radius	Suitable for	SSK
FV9 12,0-16,5 Transformaster	07	TPMT-07U	TPMR-07U		0,4	Universal	20
	07		TPMR-07U		0,4	HARDOX	
	07	TPMT-07SA			0,4	Stainless	
	07	TPMT-07SA			0,4	Aluminium	
FV 20,0 - 30,0	10	TPMT-10U			0,4	Universal	22
	10	TPMT-10U			0,4	HARDOX	
	10	TPMT-10SA			0,4	Stainless	
	10	TPMT-10SA			0,4	Aluminium	

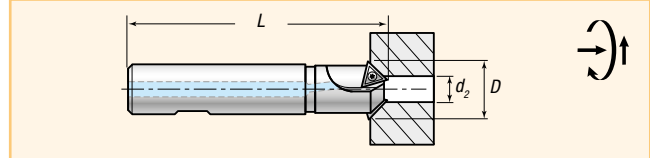

• The GRANLUND inserts have special chipbreaker angle for optimum chip control.

Cutting data for Chamfering Type FV

Material	Speed	Feed	Material	Speed	Feed
Steel <450 N/mm ²	75 - 120 m/min	0,1 - 0,5 mm/rev.	Cast Iron	80 - 110 m/min	0,1-0,5 mm/rev.
Steel <600 N/mm ²	65 - 110 m/min	0,1 - 0,4 mm/rev.	Cast Aluminium	80 - 150 m/min	0,1-1,0 mm/rev.
Steel <1000 N/mm ²	55 - 100 m/min	0,1 - 0,3 mm/rev.			

Cutting data for face milling = 1,5 x Cutting data for Chamfering.



100TSK/100TRSK*		100TB							100TTSK**	
Sets type	Type of Counterbores	Composition: Countersinks type 100 90° HSS - Ø mm							Part No.	
100TSK	100T	10,0	16,0	20,0	25,0	30,0				100TSK
100TB**	100T	6,3	8,3	10,4	12,4	16,5	20,5	25,0		100TB
100TRSK*	100TR	10,0	16,0	20,0	25,0	30,0				100TRSK
100TTSK	100TT (TiN)	10,0	16,0	20,0	25,0	30,0				100TTSK

* For stainless. **According to DIN 74, Form B fine.

What's new?

New design with extreme differential pitch, eliminates vibrations and reduces axial and radial forces. Makes an improved result by countersinking.

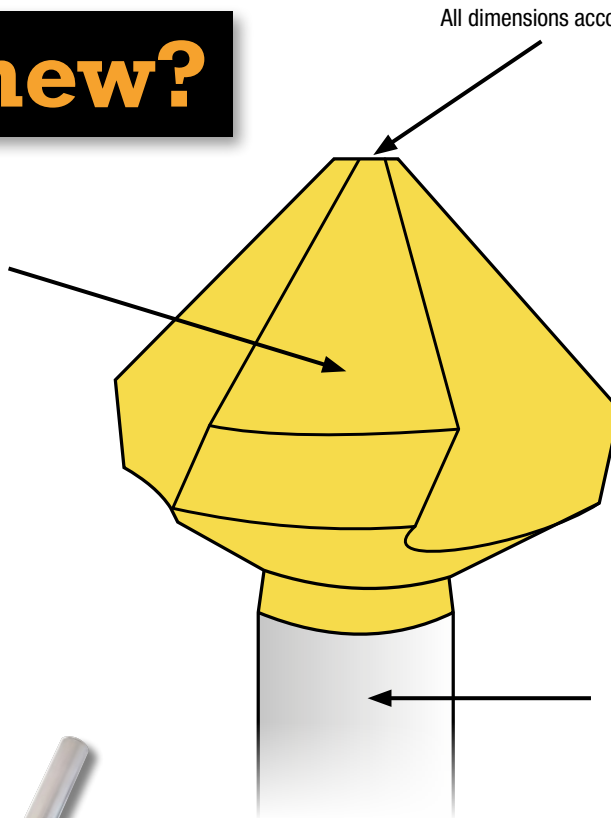
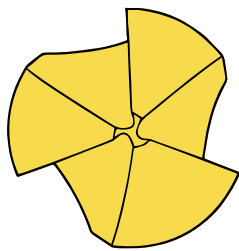

All dimensions according to DIN 335C

As always on Granlund-countersinks... Three grinded flats on the shank to improve the grip in drill chucks. Available on shank diameters 8, 10 and 12 mm.



D Ø mm	405T9 Differential Pitch	405TT9 Differential Pitch	L mm	d ₁ mm	d ₂ mm
	HSS-E	HSS-E TIN			
	Uncoated 90°	TIN-Coated 90°			
	Part No.	Part No.			
4,3	405T9-04,3	405TT9-04,3	40	4	1,5
5,3	405T9-05,3	405TT9-05,3	40	4	1,5
6,0	405T9-06,0	405TT9-06,0	45	5	1,5
6,3	405T9-06,3	405TT9-06,3	45	5	1,5
8,0	405T9-08,0	405TT9-08,0	50	6	2,0
8,3	405T9-08,3	405TT9-08,3	50	6	2,0
9,4	405T9-09,4	405TT9-09,4	50	6	2,2
10,0	405T9-10,0	405TT9-10,0	50	6	2,5
10,4	405T9-10,4	405TT9-10,4	50	6	2,5
11,5	405T9-11,5	405TT9-11,5	56	8*	2,8
12,0	405T9-12,0	405TT9-12,0	56	8*	2,8
12,4	405T9-12,4	405TT9-12,4	56	8*	2,8
15,0	405T9-15,0	405TT9-15,0	60	10*	3,2
16,5	405T9-16,5	405TT9-16,5	60	10*	3,2
20,5	405T9-20,5	405TT9-20,5	63	10*	3,5
25,0	405T9-25,0	405TT9-25,0	67	10*	3,8
28,0	405T9-28,0	405TT9-28,0	71	12*	4,0
30,0	405T9-30,0	405TT9-30,0	71	12*	4,2
31,0	405T9-31,0	405TT9-31,0	71	12*	4,2

* Cylindrical shank with 3 grinded flats.

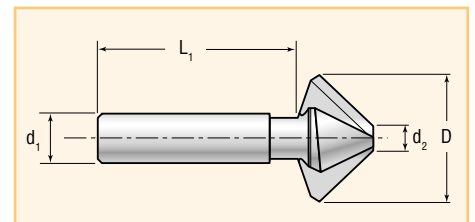

	Material	Suitable for
P	Steel <500	●
	Steel <850	●
	Steel <1200	○
M	Stainless steel <600	●
	Stainless steel <850	○
K	Cast iron	●
N	Aluminum <10% Si	●

Sets						
Part No.	Type of Countersink	Including dimensions				
405T9	405T	6,3	10,4	16,5	20,5	25,0
405TT9	405TT (TiN)	6,3	10,4	16,5	20,5	25,0



405TT9 set

Backspotfacing/chamfering tools



BV
Backspotfacer

D mm	Shank Weldon					
	d _{min.} mm	Part No.	Shank Weldon	L ₁ mm	L ₂ mm	E* mm
18,0	10,5	BV-18,0/10,5	16	35	13	4,10
20,0	13,0	BV-20,0/13,0	16	40	13	3,85
24,0	15,0	BV-24,0/15,0	20	50	13	4,65
26,0	17,0	BV-26,0/17,0	20	50	13	4,85
30,0	19,0	BV-30,0/19,0	25	60	16	5,65
33,0	21,0	BV-33,0/21,0	25	70	16	6,40
36,0	23,0	BV-36,0/23,0	25	70	16	6,65
40,0	25,0	BV-40,0/25,0	25	80	16	7,90
43,0	30,0	BV-43,0/30,0	32	90	16	7,00
46,0	30,0	BV-46,0/30,0	32	90	16	8,50
48,0	31,0	BV-48,0/31,0	32	90	16	8,90
50,0	33,0	BV-50,0/33,0	32	105	16	9,00

* = Position place.



BFV 90°
Backspotfacer

D mm	Shank Weldon					
	d _{min.} mm	Part No.	Shank Weldon	L ₁ mm	L ₂ mm	E* mm
15,0	10,0	BFV-15,0/10,0	16	35	13	2,70
20,0	14,0	BFV-20,0/14,0	16	40	13	3,20
23,0	17,0	BFV-23,0/17,0	20	50	13	3,20
27,0	21,0	BFV-27,0/21,0	25	70	13	3,20
31,0	24,0	BFV-31,0/24,0	25	80	13	3,70

* = Position place.

Special dimension available on request.



DFV 90°
Front/Backspotfacer

D mm	Shank Weldon					
	d _{min.} mm	Part No.	Shank Weldon	L ₁ mm	L ₂ mm	E* mm
15,0	10,0	DFV-15,0/10,0	16	35	13	2,70
20,0	14,0	DFV-20,0/14,0	16	40	13	3,20
23,0	17,0	DFV-23,0/17,0	25	50	13	3,20
27,0	21,0	DFV-27,0/21,0	32	70	13	3,20
31,0	24,0	DFV-31,0/24,0	32	80	13	3,70

* = Position place.

Insert for BV, BFV, DFV and FV

Type of insert	Insert for BV, BFV, DFV and FV					
Type of tools D mm	Size	Part No.	Part No.	Radius	Suitable for	SSK
BV 18,0 - 27,0 DFV 15,0 - 31,0 BFV 15,0 - 31,0	07	TPMT-07U	TPMR-07U	0,4	Universal	20
	07		TPMR-07U	0,4	HARDOX	
	07	TPMT-07SA		0,4	Stainless	
	07	TPMT-07SA		0,4	Aluminium	
BV >27,0 - 48,0	10	TPMT-10U		0,4	Universal	22
	10	TPMT-10U		0,4	HARDOX	
	10	TPMT-10M		0,4	Stainless	
	10	TPMT-10K		0,4	Aluminium	

• The GRANLUND inserts have special chipbreaker angle for optimum chip control.

Cutting data for type BV, BFV and DFV

Material	Speed	Feed	Material	Speed	Feed
Steel <450 N/mm ²	80 - 120 m/min	0,05 - 0,15 mm/rev.	Cast Iron	80 - 110 m/min	0,05 - 0,15 mm/rev.
Steel <600 N/mm ²	60 - 110 m/min	0,05 - 0,15 mm/rev.	Cast Aluminium	80 - 150 m/min	0,05 - 0,15 mm/rev.
Steel <1000 N/mm ²	50 - 100 m/min	0,05 - 0,15 mm/rev.			

BV, Backspotfacer

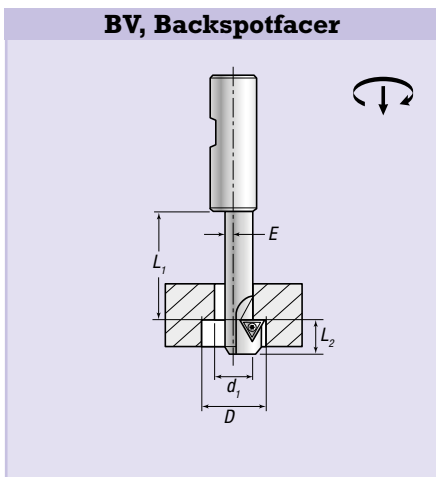

BFV 90°, Backspotfacer

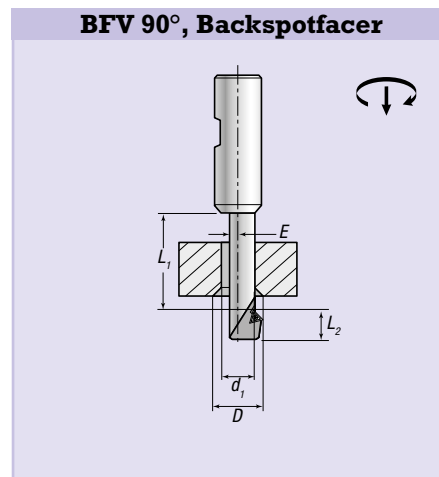

DFV 90°, Front/Backspotfacer

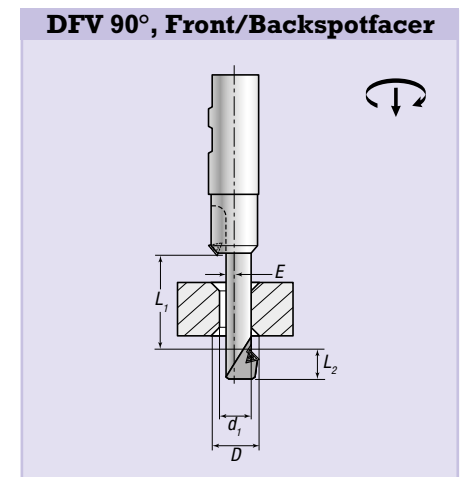



powered by water



The waterdriven backspotfacer developed by Granlund Tools

With the Neptune backspotfacer you can produce spotfaces of up to 2 times the diameter of the hole. As a special the tool can be manufactured for an even wider range.

Neptune is powered by coolant through the spindle. It operates using a piston in the shank, which pushes the insert holder out.

The Neptune is a combination tool, where you can strip, and clean the parts, change insert holder for another dimension etc.

The tool is also equipped with an “emergency” function. The shank separates from the holder in case the insert holder doesn’t retract properly. The spindle needs to be reversed during retraction after the spotfacing to ensure that the emergency function operates.

All friction parts are coated with a low friction coating to ensure the function of the tool.

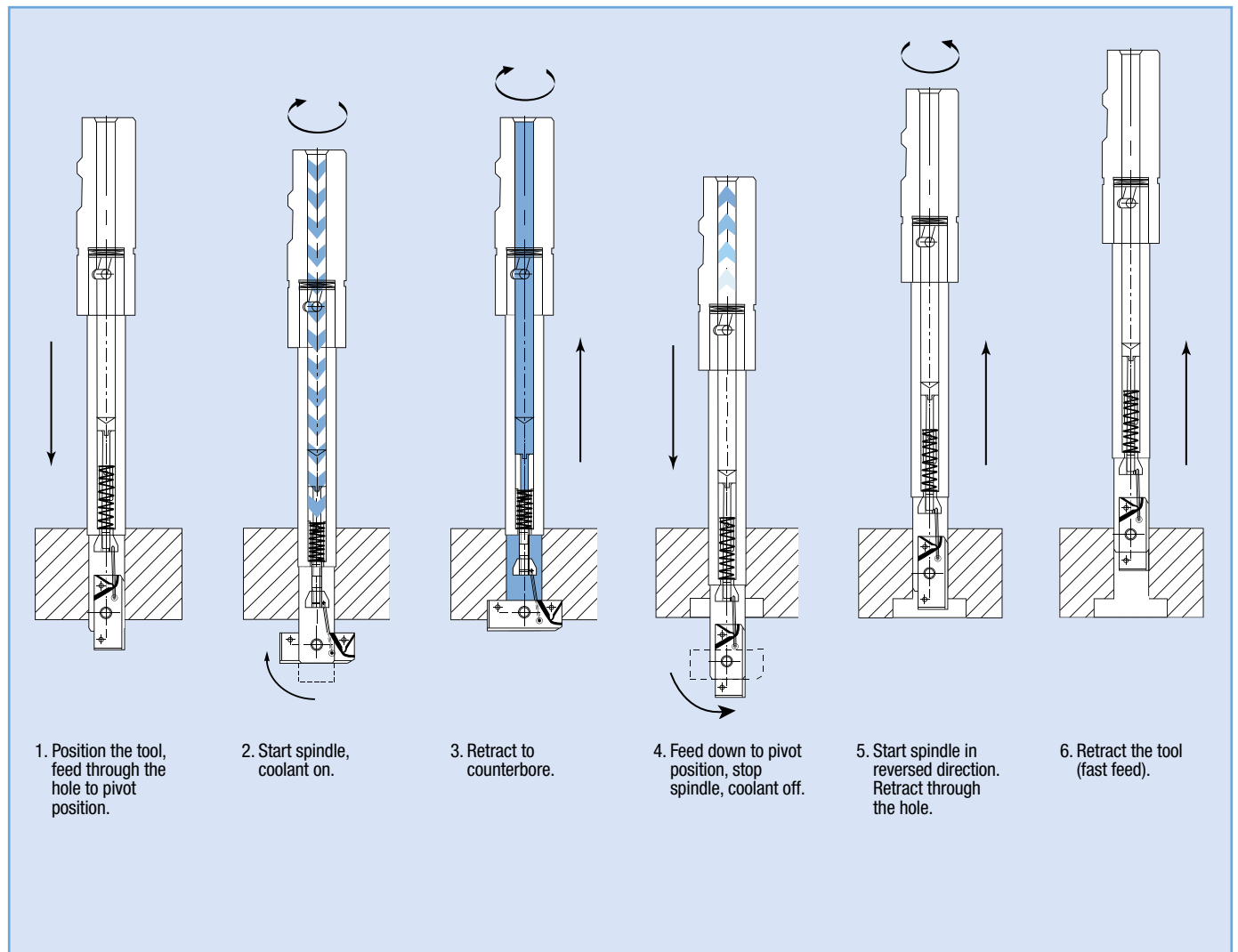

Cutting data for backspotfacer type NE

Workpiece	Speed	Feed
Steel <450 N/mm	50-100 m/min	0,05-0,15 mm/rev.
Steel <600 N/mm	60-110 m/min	0,05-0,15 mm/rev.
Steel <1000 N/mm	50-100 m/min	0,05-0,15 mm/rev.
Cast iron	80-100 m/min	0,10-0,15 mm/rev.
Cast aluminium	80-150 m/min	0,05-0,15 mm/rev.

Operating reversed during retraction

Speed	Feed
400 rpm	500 mm/min

N240 G73 Z600 M5
 N250 G73 X710
 N260 M6
 N270 G57 H901
 N280 G43 Z100. H3 S770
 N290 X0 Y0
 N300 Z50.
 N310 G1 Z-50. F500
 N320 M50
 N330 M3
 N340 G1 Z-33. F200
 N350 G1 Z-27. F77
 N360 G0 Z-50. M9
 N370 G4 P5
 N380 S400 M4
 N390 G1 Z50. F500
 N400 G73 Z600 M5
 N410 M60
 N420 G53
 N430 M30
 %

Application example:

Tool:
NE-17,0/33,0
 Workpiece:
SS 1672 t=33 mm
 Spotface: 3 mm

Sparepart kit

Typ	1 set contains:	
NESK-13	2 x Link	1 x Distributor
NESK-15		
NESK-17		
NESK-19	1 x Spring	1 x Screw
NESK-21		
NESK-23		
NESK-25	2 x Axle	4 x Nut
NESK-33		

CAUTION!

Do not operate the tool as single flute. If there is to be any intermittent cutting the feed rate should be reduced by at least 50%.

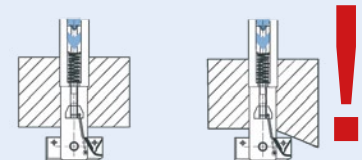

NEPTUNE

Part No.	Inserts	Screws	d_1	D	L_1	L_2	L_3	Shank Weldon
NE-13,0/26,0	TPMT-07U	SSK-20-S	13	26	90	10	26	25
NE-15,0/30,0		SSK-20-S	15	30	90	10	30	25
NE-17,0/26,0		SSK-20	17	26	110	10	26	25
NE-17,0/33,0	TPMT-10U	SSK-22-S	17	33	110	10	33	25
NE-19,0/36,0		SSK-22-S	19	36	110	10	36	25
NE-21,0/33,0		SSK-22	21	33	110	10	33	25
NE-21,0/40,0		SSK-22	21	40	110	10	40	25
NE-23,0/43,0		SSK-22	23	43	110	10	43	32
NE-25,0/40,0		SSK-22	25	40	125	15	40	32
NE-25,0/48,0	TPMT-17U	SSK-40	25	48	125	15	48	32
NE-33,0/61,0		SSK-40	33	61	140	30	61	40

Important!

- Coolant through the spindle or by means of a coolant adapter is required to operate the tool. For reliable operation the pressure should be ≥ 3 bars and the flow ≥ 30 l/min. Before using the tool, make sure that the insert holder pivots freely, lubricate and clean if necessary.

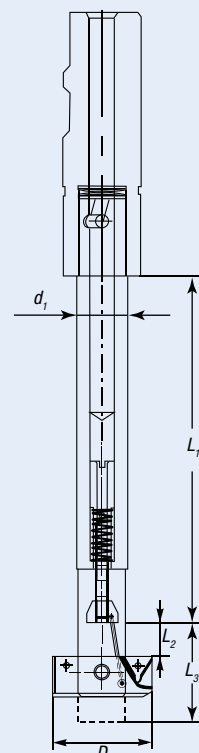

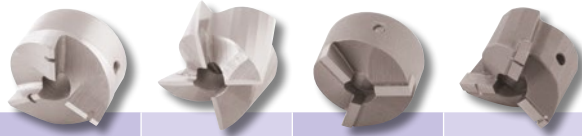

Size d mm			U	UD	UH	UDH
	D mm	L mm	HSS Tol. k12	HSS Tol. p8	Carbide K40 Tol. k12	Carbide K40 Tol. p8
			Part No.	Part No.	Part No.	Part No.
6	12,0	17	U-06/12	UD-06/12	UH-06/12	UDH-06/12
	13,0	17	U-06/13	UD-06/13	UH-06/13	UDH-06/13
	13,5	17	U-06/13,5		UH-06/13,5	
	14,0	17	U-06/14	UD-06/14	UH-06/14	UDH-06/14
	14,5	17	U-06/14,5	UD-06/14,5		UDH-06/14,5
	15,0	17	U-06/15		UH-06/15	UDH-06/15
	16,0	17	U-06/16	UD-06/16	UH-06/16	UDH-06/16
	17,0	17	U-06/17	UD-06/17	UH-06/17	UDH-06/17
	18,0	17	U-06/18	UD-06/18	UH-06/18	UDH-06/18
	19,0	17	U-06/19		UH-06/19	
	20,0	17	U-06/20	UD-06/20	UH-06/20	UDH-06/20
	22,0	17	U-06/22	UD-06/22	UH-06/22	UDH-06/22
	24,0	17	U-06/24			
	26,0	17	U-06/26			
9	16,0	21	U-09/16		UH-09/16	
	17,0	21	U-09/17		UH-09/17	
	17,5	21		UD-09/17,5		UDH-09/17,5
	18,0	21	U-09/18	UD-09/18	UH-09/18	UDH-09/18
	19,0	21	U-09/19	UD-09/19	UH-09/19	UDH-09/19
	20,0	21	U-09/20	UD-09/20	UH-09/20	UDH-09/20
	21,0	21	U-09/21	UD-09/21	UH-09/21	UDH-09/21
	22,0	21	U-09/22	UD-09/22	UH-09/22	UDH-09/22
	23,0	21	U-09/23	UD-09/23	UH-09/23	UDH-09/23
	24,0	21	U-09/24	UD-09/24	UH-09/24	UDH-09/24
	25,0	21	U-09/25	UD-09/25	UH-09/25	UDH-09/25
	26,0	21	U-09/26	UD-09/26	UH-09/26	UDH-09/26
	28,0	21	U-09/28	UD-09/28	UH-09/28	UDH-09/28
	30,0	21	U-09/30	UD-09/30	UH-09/30	UDH-09/30
32,0	21	U-09/32	UD-09/32	UH-09/32	UDH-09/32	
33,0	21	U-09/33				
34,0	21	U-09/34	UD-09/34	UH-09/34	UDH-09/34	
14	24,0	27	U-14/24	UD-14/24	UH-14/24	UDH-14/24
	25,0	27	U-14/25	UD-14/25		UDH-14/25
	26,0	27	U-14/26	UD-14/26	UH-14/26	UDH-14/26
	27,0	27	U-14/27		UH-14/27	
	28,0	27	U-14/28	UD-14/28	UH-14/28	UDH-14/28
	30,0	27	U-14/30	UD-14/30	UH-14/30	UDH-14/30
	32,0	27	U-14/32	UD-14/32	UH-14/32	UDH-14/32
	33,0	27	U-14/33	UD-14/33	UH-14/33	UDH-14/33
	34,0	27	U-14/34	UD-14/34	UH-14/34	UDH-14/34
	35,0	27	U-14/35	UD-14/35	UH-14/35	UDH-14/35
	36,0	27	U-14/36	UD-14/36	UH-14/36	UDH-14/36
	38,0	27	U-14/38	UD-14/38	UH-14/38	UDH-14/38
	40,0	27	U-14/40	UD-14/40	UH-14/40	UDH-14/40
	41,0	27	U-14/41	UD-14/41	UH-14/41	UDH-14/41
20	32,0	31	U-20/32		UH-20/32	
	32,0	31	U-20/33		UH-20/33	
	34,0	31	U-20/34		UH-20/34	
	35,0	31	U-20/35	UD-20/35	UH-20/35	UDH-20/35
	36,0	31	U-20/36	UD-20/36	UH-20/36	UDH-20/36
	38,0	31	U-20/38	UD-20/38	UH-20/38	UDH-20/38
	40,0	31	U-20/40	UD-20/40	UH-20/40	UDH-20/40
	42,0	31	U-20/42	UD-20/42	UH-20/42	UDH-20/42
	43,0	31	U-20/43			
	44,0	31	U-20/44	UD-20/44		UDH-20/44
	45,0	31	U-20/45	UD-20/45	UH-20/45	UDH-20/45
	46,0	31	U-20/46	UD-20/46	UH-20/46	UDH-20/46
	48,0	31	U-20/48	UD-20/48	UH-20/48	UDH-20/48
	50,0	31	U-20/50	UD-20/50	UH-20/50	UDH-20/50
52,0	31	U-20/52	UD-20/52	UH-20/52	UDH-20/52	
55,0	31	U-20/55	UD-20/55	UH-20/55	UDH-20/55	
57,0	31	U-20/57	UD-20/57	UH-20/57	UDH-20/57	
30	60,0	38	U-30/60	UD-30/60	UH-30/60	UDH-30/60
	62,0	38	U-30/62	UD-30/62	UH-30/62	UDH-30/62
	64,0	38	U-30/64	UD-30/64		UDH-30/64
	65,0	38	U-30/65	UD-30/65	UH-30/65	UDH-30/65
	68,0	38	U-30/68	UD-30/68	UH-30/68	UDH-30/68
	70,0	38	U-30/70	UD-30/70	UH-30/70	UDH-30/70
	71,0	38	U-30/71			
	72,0	38	U-30/72	UD-30/72	UH-30/72	UDH-30/72
	75,0	38	U-30/75	UD-30/75	UH-30/75	UDH-30/75
	76,0	38		UD-30/76	UH-30/76	UDH-30/76
	80,0	38	U-30/80	UD-30/80	UH-30/80	UDH-30/80
	82,0	38	U-30/82			
	83,0	38	U-30/83			

Type U, UD, UH and UDH

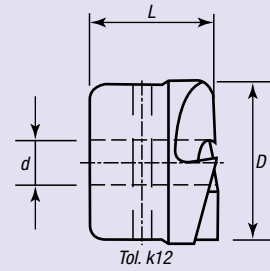

Type U

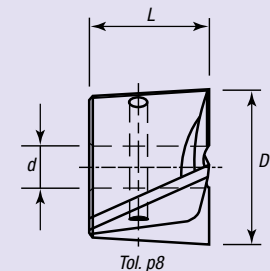

Type UD

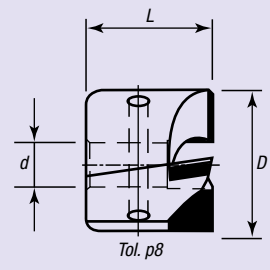

Type UDH

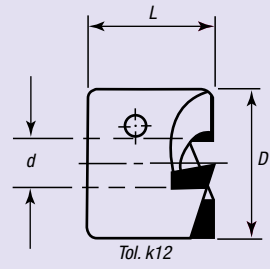

Type UH

Larger and intermediate sizes available on request.

Backspotfacing system



US MT						
Size d mm	d ₁ mm	L ₁ mm	L ₂ mm	Shank	Type US	
	Part No.					
6	6,0*	55	92	MK1	US-06/06,0-MK1	
	6,5*	55	92	MK1	US-06/06,5-MK1	
	7,0*	55	92	MK1	US-06/07,0-MK1	
	7,5	55	92	MK1	US-06/07,5-MK1	
	8,0	55	92	MK1	US-06/08,0-MK1	
	8,5	55	92	MK1	US-06/08,5-MK1	
	9,0	55	92	MK1	US-06/09,0-MK1	
	9,5	55	92	MK1	US-06/09,5-MK1	
9	10,0	55	92	MK1	US-06/10,0-MK1	
	9,0*	75	116	MK2	US-09/09,0-MK2	
	9,5*	75	116	MK2	US-09/09,5-MK2	
	10,0*	75	116	MK2	US-09/10,0-MK2	
	10,5	75	116	MK2	US-09/10,5-MK2	
	11,0	75	116	MK2	US-09/11,0-MK2	
	11,5	75	116	MK2	US-09/11,5-MK2	
	12,0	75	116	MK2	US-09/12,0-MK2	
	12,5	75	116	MK2	US-09/12,5-MK2	
	13,0	75	116	MK2	US-09/13,0-MK2	
	13,5	75	116	MK2	US-09/13,5-MK2	
	14,0	75	116	MK2	US-09/14,0-MK2	
	14,5	75	116	MK2	US-09/14,5-MK2	
	15,0	75	116	MK2	US-09/15,0-MK2	
	14	14,0*	90	143	MK3	US-14/14,0-MK3
		14,5*	90	143	MK3	US-14/14,5-MK3
15,0*		90	143	MK3	US-14/15,0-MK3	
16,0		90	143	MK3	US-14/16,0-MK3	
17,0		90	143	MK3	US-14/17,0-MK3	
18,0		90	143	MK3	US-14/18,0-MK3	
19,0		90	143	MK3	US-14/19,0-MK3	
20,0		90	143	MK3	US-14/20,0-MK3	
21,0		90	143	MK3	US-14/21,0-MK3	
22,0		90	143	MK3	US-14/22,0-MK3	
20	20,0*	90	147	MK3	US-20/20,0-MK3	
	21,0*	90	147	MK3	US-20/21,0-MK3	
	22,0	90	147	MK3	US-20/22,0-MK3	
	23,0	90	147	MK3	US-20/23,0-MK3	
	24,0	90	147	MK3	US-20/24,0-MK3	
	25,0	110	169	MK4	US-20/25,0-MK4	
	26,0	110	169	MK4	US-20/26,0-MK4	
	27,0	110	169	MK4	US-20/27,0-MK4	
	28,0	110	169	MK4	US-20/28,0-MK4	
	30,0	110	169	MK4	US-20/30,0-MK4	
30	32,0	110	169	MK4	US-20/32,0-MK4	
	30,0*	130	205	MK4	US-30/30,0-MK4	
	32,0	130	205	MK4	US-30/32,0-MK4	
	33,0	130	205	MK4	US-30/33,0-MK4	
	34,0	130	205	MK4	US-30/34,0-MK4	
	35,0	130	205	MK4	US-30/35,0-MK4	
	36,0	130	205	MK4	US-30/36,0-MK4	
	38,0	130	205	MK4	US-30/38,0-MK4	
	39,0	130	205	MK4	US-30/39,0-MK4	
	40,0	130	205	MK4	US-30/40,0-MK4	
43,0	130	205	MK4	US-30/42,0-MK4		
45,0	130	205	MK4	US-30/45,0-MK4		

US Weldon						
Size d mm	d ₁ mm	L ₁ mm	L ₂ mm	Shank	Type US	
	Part No.					
6	6,0*	55	89	Weldon 12	US-06/06,0-W12	
	6,5*	55	89	Weldon 12	US-06/06,5-W12	
	7,0*	55	89	Weldon 12	US-06/07,0-W12	
	8,0	55	89	Weldon 12	US-06/08,0-W12	
	8,5	55	89	Weldon 12	US-06/08,5-W12	
	9,0	55	89	Weldon 12	US-06/09,0-W12	
	9,5	55	89	Weldon 12	US-06/09,5-W12	
	10,0	55	89	Weldon 12	US-06/10,0-W12	
	9	9,0*	75	113	Weldon 16	US-09/09,0-W16
		9,5*	75	113	Weldon 16	US-09/09,5-W16
10,0*		75	113	Weldon 16	US-09/10,0-W16	
10,5		75	113	Weldon 16	US-09/10,5-W16	
11,0		75	113	Weldon 16	US-09/11,0-W16	
11,5		75	113	Weldon 16	US-09/11,5-W16	
12,0		75	113	Weldon 16	US-09/12,0-W16	
12,5		75	113	Weldon 16	US-09/12,5-W16	
13,0		75	113	Weldon 16	US-09/13,0-W16	
14,0		75	113	Weldon 16	US-09/14,0-W16	
14	15,0	75	113	Weldon 16	US-09/15,0-W16	
	14,0*	90	139	Weldon 20	US-14/14,0-W20	
	14,5*	90	139	Weldon 20	US-14/14,5-W20	
	15,0*	90	139	Weldon 20	US-14/15,0-W20	
	16,0	90	139	Weldon 20	US-14/16,0-W20	
	17,0	90	139	Weldon 20	US-14/17,0-W20	
	18,0	90	139	Weldon 20	US-14/18,0-W20	
	19,0	90	139	Weldon 20	US-14/19,0-W20	
	20,0	90	139	Weldon 20	US-14/20,0-W20	
	21,0	90	139	Weldon 20	US-14/21,0-W20	
20	22,0	90	139	Weldon 20	US-14/22,0-W20	
	20,0*	110	163	Weldon 20	US-20/20,0-W20	
	21,0*	110	163	Weldon 20	US-20/21,0-W20	
	22,0	110	163	Weldon 20	US-20/22,0-W20	
	23,0	110	163	Weldon 20	US-20/23,0-W20	
	24,0	110	163	Weldon 20	US-20/24,0-W20	
	25,0	110	163	Weldon 20	US-20/25,0-W20	
	26,0	110	163	Weldon 20	US-20/26,0-W20	
	27,0	110	163	Weldon 20	US-20/27,0-W20	
	28,0	110	163	Weldon 20	US-20/28,0-W20	
30	30,0	110	163	Weldon 20	US-20/30,0-W20	
	32,0	110	163	Weldon 20	US-20/32,0-W20	
	30,0*	130	195	Weldon 25	US-30/30,0-W25	
	32,0	130	195	Weldon 25	US-30/32,0-W25	
	33,0	130	195	Weldon 25	US-30/33,0-W25	
	34,0	130	195	Weldon 25	US-30/34,0-W25	
	35,0	130	195	Weldon 25	US-30/35,0-W25	
	36,0	130	195	Weldon 25	US-30/36,0-W25	
	38,0	130	195	Weldon 25	US-30/38,0-W25	
	39,0	130	195	Weldon 25	US-30/39,0-W25	
40,0	130	195	Weldon 25	US-30/40,0-W25		
42,0	130	195	Weldon 25	US-30/42,0-W25		
45,0	130	195	Weldon 25	US-30/45,0-W25		

* Not to be used combined with carbide cutters.

	Strength N/mm ²	HSS	HSS	Carbide	Carbide
	Hardness HB	Vc	f	Vc	f
P	<600 N/mm ²	15-30	0,1-0,5	30-70	0,1-0,5
	>600 N/mm ²	5-20	0,05-0,3	20-50	0,1-0,3
M	Stainless Steel	8-15	0,1-0,3	30-70	0,1-0,3
K	<220 HB	10-35	0,1-0,4	50-90	0,1-0,4
N	Aluminium	40-90	0,1-0,5	50-120	0,1-0,5

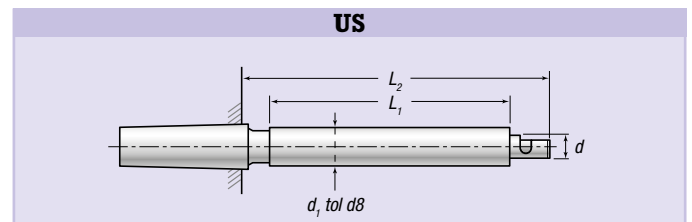

Removable tang (Spare part)

For shank	Thread	Part. No.
MK3	M12	GR1801-12-2
MK4	M16	GR1801-12-1



Ø D mm					RD	RA	RB
	Tol. h6 d mm	L ₁ mm	L ₂ mm	Insert size	For through and blind holes Part No.	For through holes Part No.	For blind holes Part No.
10	16	85	48	04	RD-10,0*		
11	16	85	48	04	RD-11,0*		
12	16	120	48	04	RD-12,0		
13	16	120	48	04	RD-13,0		
14	16	120	48	04	RD-14,0		
15	20	120	50	04	RD-15,0		
16	20	120	50	08		RA-16,0	RB-16,0
17	20	120	50	08		RA-17,0	RB-17,0
18	20	120	50	08		RA-18,0	RB-18,0
19	20	120	50	08		RA-19,0	RB-19,0
20	20	120	50	08		RA-20,0	RB-20,0
21	20	120	50	11		RA-21,0	RB-21,0
22	20	120	50	11		RA-22,0	RB-22,0
23	20	120	50	11		RA-23,0	RB-23,0
24	20	120	50	11		RA-24,0	RB-24,0
25	20	120	50	11		RA-25,0	RB-25,0
26	20	120	50	11		RA-26,0	RB-26,0
27	20	120	50	11		RA-27,0	RB-27,0
28	20	120	50	11		RA-28,0	RB-28,0
29	20	120	50	11		RA-29,0	RB-29,0
30	20	120	50	11		RA-30,0	RB-30,0
31	20	120	50	11		RA-31,0	RB-31,0
32	20	120	50	11		RA-32,0	RB-32,0
33	20	120	50	11		RA-33,0	RB-33,0
34	20	120	50	11		RA-34,0	RB-34,0
35	20	120	50	11		RA-35,0	RB-35,0
36	20	120	50	11		RA-36,0	RB-36,0
37	20	120	50	11		RA-37,0	RB-37,0
38	25	120	56	11		RA-38,0	RB-38,0
39	25	120	56	11		RA-39,0	RB-39,0
40	25	120	56	11		RA-40,0	RB-40,0
41	25	120	56	11		RA-41,0	RB-41,0
42	25	120	56	11		RA-42,0	RB-42,0
43	25	120	56	11		RA-43,0	RB-43,0
44	25	120	56	11		RA-44,0	RB-44,0
45	25	120	56	11		RA-45,0	RB-45,0
46	25	120	56	11		RA-46,0	RB-46,0
47	25	120	56	11		RA-47,0	RB-47,0
48	25	120	56	11		RA-48,0	RB-48,0
49	25	120	56	11		RA-49,0	RB-49,0
50	25	120	56	11		RA-50,0	RB-50,0

RD adjustment range -0 +0,03. RA, RB adjustment range -0 +0,05. * = Internal coolant standard except for RD Ø 10, 11.

Reaming

Guide to quick reamer selection

Select diameter and tolerance

Standard sizes are delivered preset to +0,008 mm from min. diameter of tolerance H7 with an uncoated insert.
The standard sizes will produce holes according to the nominal diameter of the reamer and with H7 tolerance.
The adjustability of the reamer can be used to increase the tolerance band or for fine- adjustment within a certain tolerance.
Intermediate diameters are manufactured and preset to your requirements.

Guide to quick insert selection

Uncoated DC, BC, AC

Non ferrous alloys.
Where a sharp cutting edge is required.



TiN coated DCT, BCT, ACT

High cutting data. Long tool-life.
Not suitable for aluminium.



Cermet DCC, BCC, ACC

For steel and grey cast iron.
High cutting speed. Durable. Wear resistant.
Other coatings can be offered on request.

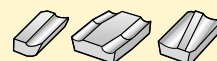

RD, RA and RB

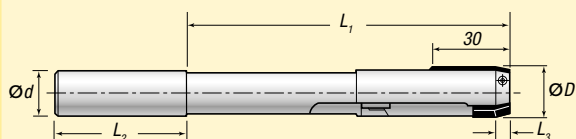

Insert	For type	ØD range	Diagram
DC-04 DCT-04 DCC-04	RD	09,90 - 15,90	
BC-08 BCT-08 BCC-08	RB	15,91 - 21,60	
BC-11 BCT-11 BCC-11	RB	21,61 - 120,0	
AC-08 ACT-08 ACC-08	RA	15,91 - 21,60	
AC-11 ACT-11 ACC-11	RA	21,61 - 120,0	

Material		Cutting data indexable insert reamer							
		Feed	Uncoated Coolant supply		TiN coated Coolant supply		Cermet Coolant		
			mm/rev.	Internal	External	Internal	External	Internal	
P	Steel	<700N/mm ²	0,1 - 0,4	20 - 60	12 - 25	25 - 70	15 - 30	100 - 300	
	Steel	<1000 N/mm ²	0,1 - 0,4	15 - 40	10 - 18	25 - 45	15 - 25	100 - 200	
	Steel	>1000 N/mm ²	0,1 - 0,4	20 - 40	8 - 15	25 - 45	10 - 20	100 - 130	
	Cast steel	>800 N/mm ²	0,1 - 0,4	20 - 50	10 - 20	25 - 60	10 - 25	-	
M	Stainless		0,1 - 0,3	15 - 30	7 - 15	10 - 30	7 - 15	-	
	Inconel		0,1 - 0,3	10 - 20	5 - 15	10 - 20	5 - 15	-	
K	Cast Iron	<210 HB	0,15 - 0,4	30 - 70	15 - 35	20 - 70	15 - 35	100 - 300	
	Cast Iron	>210 HB	0,15 - 0,4	30 - 50	15 - 35	20 - 50	15 - 35	100 - 250	
	Malleable iron		0,1 - 0,3	30 - 50	12 - 25	15 - 50	12 - 25	-	
N	Aluminium	Short chip	0,1 - 0,3	30 - 70	12 - 30	-	-	-	
	Aluminium	Long chip	0,1 - 0,3	20 - 70	12 - 30	-	-	-	
	Bronze	Hard	0,1 - 0,3	15 - 50	6 - 20	15 - 50	6 - 20	-	
	Bronze	Soft	0,1 - 0,3	15 - 50	10 - 20	15 - 50	10 - 20	-	
	Brass	Short chip	0,1 - 0,4	25 - 70	10 - 50	25 - 70	10 - 50	-	
	Brass	Long chip	0,1 - 0,3	20 - 45	8 - 25	20 - 45	10 - 25	-	
	Copper	Hard	0,1 - 0,4	20 - 60	10 - 30	20 - 60	10 - 30	-	
	Copper	Soft	0,1 - 0,3	20 - 50	10 - 20	20 - 60	10 - 20	-	
	X	Plastic		0,1 - 0,4	30 - 70	10 - 30	30 - 70	10 - 30	-

Coolant with minimum 6% concentration recommended.

Spare parts for reamers type RA, RB, RD						
Diameter part range mm	Eccentric screw	Adjusting screw	Wedge	Pivot	Hexagon key	Spare set
9,90-12,90	ES-3	AS-3	W-1	F-04	SN-1,5 SN-2,0	RSB-01
12,91-15,90	ES-3	AS-3	W-2	F-04	SN-1,5 SN-2,0	RSB-02
15,91-17,90	ES-3	AS-3	W-2	F-08	SN-1,5 SN-2,5	RSB-02
17,91-21,60	ES-4	AS-5	W-3	F-08	SN-2,5	RSB-04
21,61-23,60	ES-4	AS-5	W-3	F-11	SN-2,5	RSB-05
23,61-30,60	ES-4	AS-5	W-4	F-11	SN-2,5	RSB-06
30,61-34,60	ES-4	AS-5	W-5	F-11	SN-2,5	RSB-07
34,61-50,00	ES-4	AS-5	W-6	F-11	SN-2,5	RSB-08

		Special			
		No internal coolant		With internal coolant	
		MIN. mm	MAX. mm	MIN. mm	MAX. mm
L _s = Length of guide pad	L _s	30,0	120	30	120
L ₁ = Reamer working length	L ₁	60,0	1000	60	1000
D = Reamer diameter	D*	9,9	120	12	120
d = Shank diameter	d	10,0	50	16	50

*Cylindrical Shank is standard, can also be manufactured with Weldon Shank.

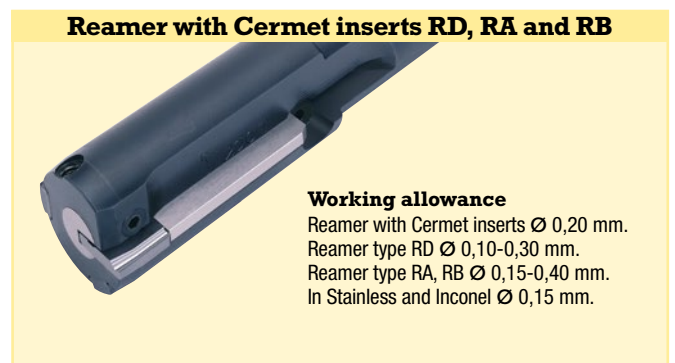
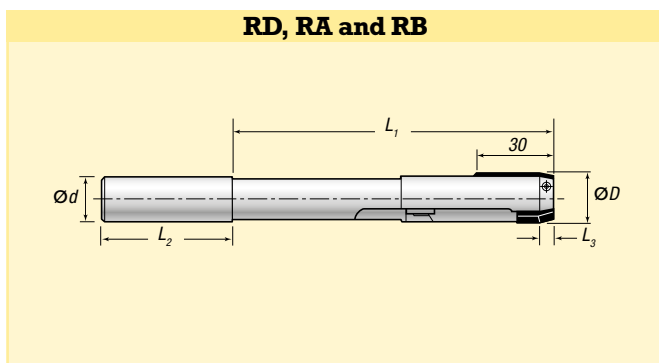

Carbide reamers, re-sizeable and fixed



H7 D mm	507					507C					509				509C				509CC							
	Carbide K10					Carbide K10					Carbide K10				Carbide K10				Cermet							
	L ₁	L ₂	L ₃	Shank MT	Part No.	L	L ₁	L ₂	L ₃	Shank cyl. d	Part No.	L ₁	L ₂	Shank MT	Part No.	L	L ₁	L ₂	Shank cyl. d	Part No.	L	L ₁	L ₂	Shank cyl. d	Part No.	
6,0	73	32		1	507-06	102	57	32		10	507C-06															
7,0	85	32		1	507-07	114	69	32		10	507C-07															
8,0	91	32		1	507-08	122	75	32		10	507C-08	91	16	1	509-08	122	75	16	10	509C-08						
9,0	97	36		1	507-09	130	81	36		10	507C-09	97	20	1	509-09	130	81	20	10	509C-09						
10,0	103	40		1	507-10	140	87	40		10	507C-10	103	20	1	509-10	140	87	20	10	509C-10						
11,0	110	40		1	507-11	149	96	40		10	507C-11	110	20	1	509-11	149	96	20	10	509C-11						
12,0	117	20	45	1	507-12	158	105	20	45	10	507C-12	117	20	1	509-12	158	105	20	10	509C-12	158	105	20	10	509CC-12	
13,0	117	20	45	1	507-13	158	105	20	45	10	507C-13	117	20	1	509-13	158	105	20	10	509C-13	158	105	20	10	509CC-13	
14,0	124	20	45	1	507-14	166	110	20	45	16	507C-14	124	20	2	509-14	166	110	20	16	509C-14	166	110	20	16	509CC-14	
15,0	124	20	50	2	507-15	182	112	20	50	20	507C-15	124	30	2	509-15	182	112	30	20	509C-15	182	112	30	20	509CC-15	
16,0	130	20	50	2	507-16	190	120	20	50	20	507C-16	130	30	2	509-16	190	120	30	20	509C-16	190	120	30	20	509CC-16	
17,0	134	20	50	2	507-17	193	123	20	50	20	507C-17	134	30	2	509-17	193	123	30	20	509C-17	193	123	30	20	509CC-17	
18,0	139	20	56	2	507-18	200	130	20	56	20	507C-18	139	30	2	509-18	200	130	30	20	509C-18	200	130	30	20	509CC-18	
19,0	143	20	56	2	507-19	201	131	20	56	20	507C-19	143	30	2	509-19	201	131	30	20	509C-19	201	131	30	20	509CC-19	
20,0	148	20	60	2	507-20	207	137	20	60	20	507C-20	148	30	2	509-20	207	137	30	20	509C-20	207	137	30	20	509CC-20	
22,0	157	20	64	2	507-22							157	30	2	509-22	227	157	30	20	509C-22						
23,0	161	20	64	2	507-23							161	30	2	509-23	231	161	30	20	509C-23						
24,0	169	20	70	3	507-24							169	30	3	509-24	239	169	30	20	509C-24						
25,0	169	20	70	3	507-25							169	30	3	509-25	239	169	30	20	509C-25						
26,0	174	20	70	3	507-26							174	30	3	509-26	244	174	30	20	509C-26						
28,0	178	30	70	3	507-28							178	30	3	509-28	248	178	30	25	509C-26						
30,0	182	30	70	3	507-30							182	30	3	509-30	252	182	30	25	509C-30						
35,0	197	30	78	4	507-35																					
40,0	205	30	78	4	507-40																					

Typ 507 Reamer

Solid reamer, left hand spiral 8-10°, extreme differential pitch. Solid carbide tip 6-11 mm, brazed flutes Ø 12-40 mm. Grade ISO K10. DIN8094 Form B.

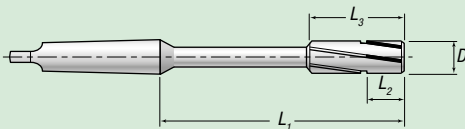
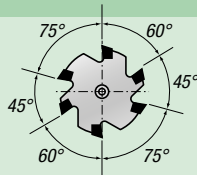

Typ 507C Reamer

Solid reamer, left hand spiral 8-10°, extreme differential pitch. Solid carbide tip 6-11 mm, brazed flutes Ø 12-40 mm. Grade ISO K10.

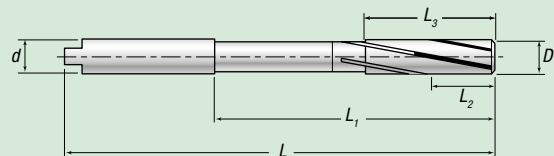
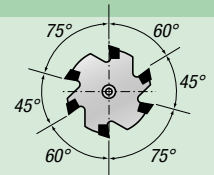

Typ 509 Reamer

Solid reamer, straight flutes, extreme differential pitch. Grade ISO K10. DIN 8051 Form A.

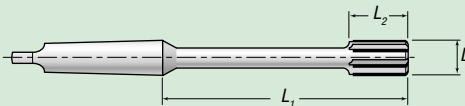
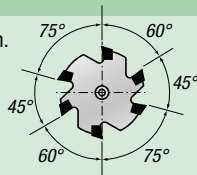

Typ 509C Reamer

Solid reamer, straight flutes, extreme differential pitch. Grade ISO K10.

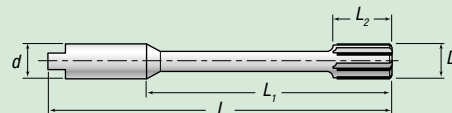
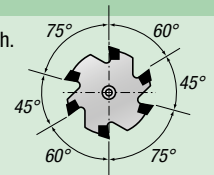

Typ 509CC Reamer

Solid reamer, straight flutes, extreme differential pitch. Cermet: high cutting speed and wear resistance in steel and cast iron applications. The optimum solution when the cutting conditions are stable.

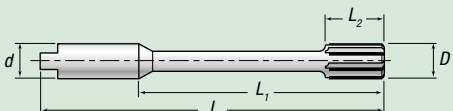
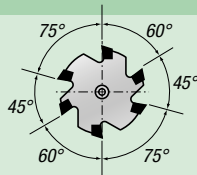

Common features:

- Reamers are stocked in tolerance H7 and also semi-finished for quick conversion to customers' requirements.
- Differential pitched flutes, for round holes and elimination of vibration.
- Lapped flutes for a better surface finish.

Fully floating toolholders for reamers



H7 D mm	510C				511 (Re-sizeable)				
	Carbide K10				Carbide K10				
	L ₁	L ₂	Shank cyl. d	Part No.	L ₁	L ₂	No. of flute	Shank MT	Part No.
4,0	90	16	4,0	510C-04					
5,0	90	16	5,0	510C-05					
6,0	110	16	5,0	510C-06					
7,0	120	16	6,0	510C-07					
8,0	120	16	7,0	510C-08	100	20	4	1	511-08
9,0	120	20	8,0	510C-09	100	20	4	1	511-09
10,0	130	20	9,0	510C-10	100	20	4	1	511-10
11,0	130	20	10,0	510C-11	100	20	4	1	511-11
12,0	130	20	11,0	510C-12	100	20	4	1	511-12
13,0	140	30	12,0	510C-13	115	20	6	1	511-13
14,0	140	30	12,0	510C-14	115	20	6	1	511-14
15,0					116	20	6	2	511-15
16,0					116	30	6	2	511-16
17,0					116	30	6	2	511-17
18,0					116	30	6	2	511-18
19,0					136	30	6	2	511-19
20,0					136	30	6	2	511-20
22,0					156	30	6	2	511-22
24,0					162	30	6	3	511-24
25,0					162	30	6	3	511-25
26,0					162	30	8	3	511-26
28,0					162	30	8	3	511-28
30,0					182	30	8	3	511-30

Type	Shank	Internal fitting	d	D	L	L ₂	L ₃	S	α°	Part No.
520	MK2	MK1	18	51	200	74	123	3,0	1,5	520-MK2/1
	MK2	MK2	23	51	210	87	136	3,0	1,5	520-MK2/2
	MK3	MK2	23	51	232	87	137	3,0	1,5	520-MK3/2
	MK3	MK3	33	57	258	107	162	2,0	1,0	520-MK3/3
	MK4	MK3	33	57	280	107	164	2,0	1,0	520-MK4/3
	MK4	MK4	41	75	321	132	202	2,4	1,0	520-MK4/4
522*	MK2	∅ 2,8-13 mm	37	57	166	36	92	2,0	1,0	522-MK2/13

* The holder is delivered with collet 440.

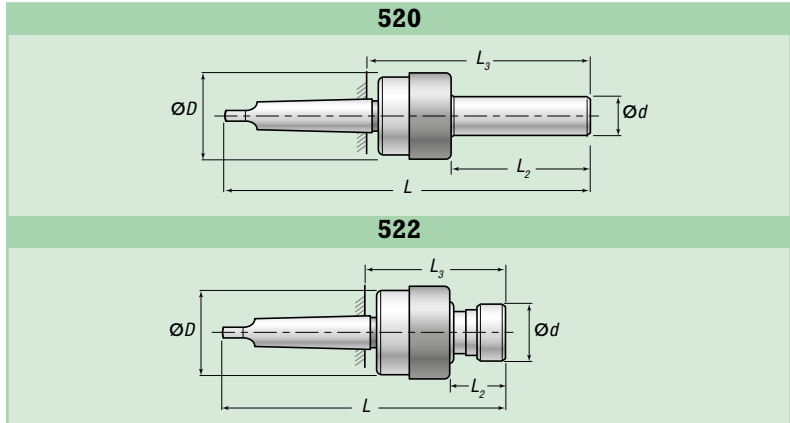

Type 511 Reamer

Re-sizeable reamer, straight flutes, differential pitch, for through holes. Grade ISO K10. The expanding reamer can be resized to offset wear by driving the expansion plug further into the reamer. Resizing can normally be done 2-3 times with regrinding. Driving the plug 1 mm further into the reamer will increase the diameter by 0,033 mm. Note: Type 511 reamer cannot be resized to smaller diameters.

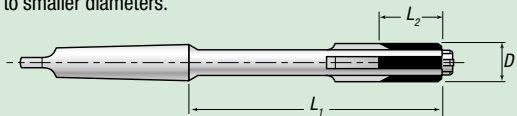
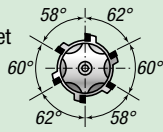

Floating holders for reamers

These have been designed to compensate parallel and angular mis-alignment of the reamer and the workpiece. Using a floating holder for reaming will improve surface finish and the life expectancy of the reamer.

The stiffness can be adjusted by a screw to obtain a perfect balance to compensate the weight of the reamer. This is of utmost importance when the machine spindle works horizontally.

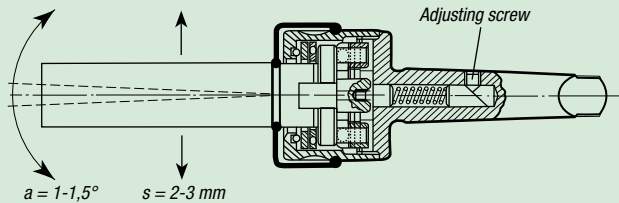

Working allowance

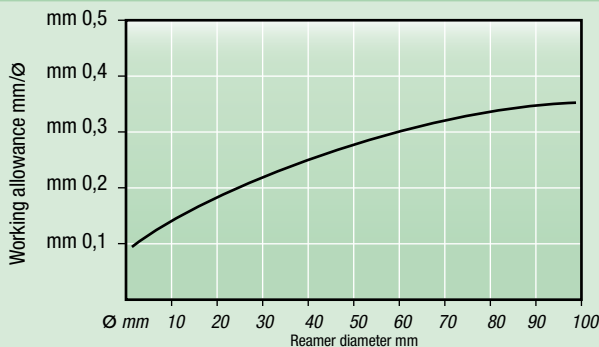

Cutting data for carbide reamers

Material	Tensile strength N/mm ²	Cutting speed m/min.	Feed mm/rev.
	Hardness HB		
P Steel	< 600	10,0 - 15,0	0,20 - 0,50
Steel	< 1000	5,0 - 12,0	0,10 - 0,40
M Stainless steel	> 1000	5,0 - 10,0	0,10 - 0,25
K Cast steel	< 500	15,0 - 20,0	0,20 - 0,50
Cast steel	> 500	10,0	0,15 - 0,40
Cast iron	< 200 HB	20,0 - 30,0	0,30 - 0,80
Cast iron	> 200 HB	15,0 - 20,0	0,20 - 0,40
N Brass		30,0 - 40,0	0,20 - 0,80
Alu. Alloys		60,0 - 80,0	0,40 - 0,80
X Plastic, hard		20,0	0,20 - 0,40

Type 510C Straight Shank Reamer

Solid reamer, straight flutes, differential pitch. Grade ISO K10. Solid carbide tip 4-8 mm, brazed flutes 9-14 mm.

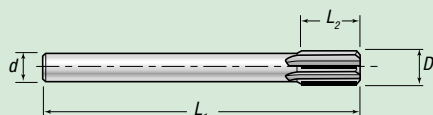

Collets

Type	Range mm	Jacobs	
		For holder type	Part No.
Jacobs	2,8 - 7,0	522	443
Jacobs	7,0 - 13,0	522	440

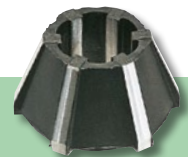

Rotating and fixed precision centres – carbide tipped

Carbide tipped Rotating centre type 609

Rotating centre type 609 is excellent for applications such as hard turning, where you want a steady operation with a minimum of heat spreading. 609 is a high quality and tough centre that Granlund Tools has a long going experience of manufacturing. We also use our rotating centre in our own production.

- Roundness of 0,002 mm
- Extra long tip allowing more space for machining
- Grinded house and spindle in hardened steel
- High tolerance ball bearings
- Fluid resistant

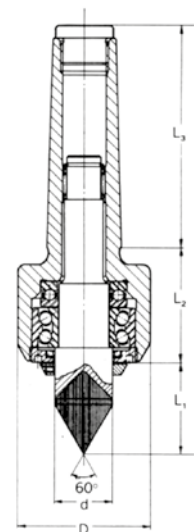

Part No.	Shank MK	D mm	d mm	L mm	L1 mm	L2 mm	L3 mm
609-MK2	2	46	19	145	35	45	65
609-MK3	3	60	25	183	45	55	83
609-MK4	4	68	27	216	50	60	106
609-MK5	5	80	34	260	55	70	135

Load table for type 609							
Shank MK	Axial preass-ure kg	r/min					
		40	200	400	1000	2000	4000
Radial load – kg							
2	600	240	160	120	90	70	50
3	950	500	340	270	200	160	130
4	1300	1000	600	480	350	280	220
5	1700	1400	800	640	470	380	300

The loading values has been calculated with a high safety factor and are calculated at a runtime of 2500 hours. At lower runtimes, these values can be exceeded. Please contact your Granlund representative if you need more information.

Turning and grinding centres type 610A and 611 – carbide tipped



Typ 610 A
Turning centre with Solid carbide tip.

Typ 611
Grinding centre with sliced carbide tip

Part No.	Part No.	Shank MK	Type 610-611 d mm	Type 610-611 b mm	L mm	L1 mm	Type 611 K mm	Type 611 K mm
610A-MK2	611-MK2	2	8	16	110	41	3,2	18,0
610A-MK3	611-MK3	3	10	20	130	44,5	4	24,0
610A-MK4	611-MK4	4	12	22	160	51,5	5	31,5
610A-MK5	611-MK5	5	14	25	200	62	6	*44,4

* Carbide Ø 35 mm

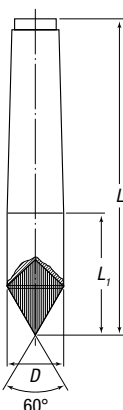

Typ 610 A

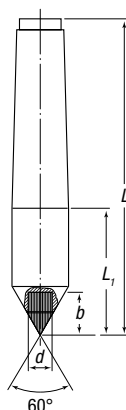

Typ 611

Special centres

Granlund Tools manufactures special centres on request. Please contact your Granlund representative for a quotation.

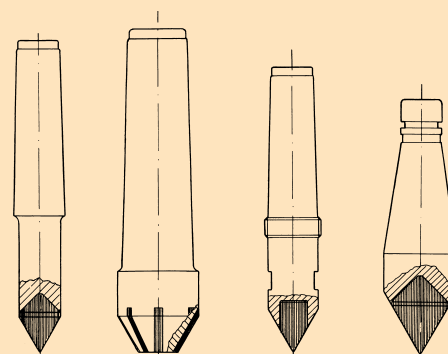

THUNDER drill for HARDOX

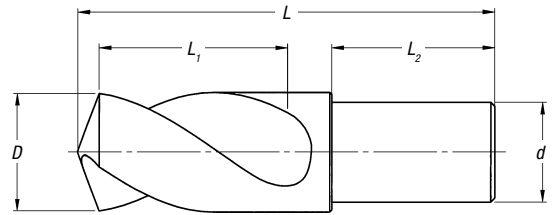

T80 is a solid carbide drill with internal coolant supply and a drill bit specially developed for drilling in HARDOX™. T80 also has a special coating for optimum performance. T80 stands for maximum recommended speed in HARDOX™ 500 (80 m/min).

With T80 and the HD drill Granlund Tools is able to offer a complete tool palette for drilling, counterboring and counter-sinking in HARDOX™. This is possible together with the existing "H"-insert for our indexable counterbores and countersinks WHV and KV.



Part No.	D	d	L ₁ (cutting length)	L ₂	L
T80-10,0	10,0	10,0	36,0	41,0	82,0
T80-12,0	12,0	12,0	36,0	41,0	82,0
T80-13,5	13,5	12,0	36,0	41,0	82,0
T80-14,0	14,0	14,0	36,0	41,0	82,0
T80-15,5	15,5	14,0	36,0	41,0	82,0
T80-17,5	17,5	16,0	55,0	41,0	103,0
T80-18,0	18,0	16,0	60,0	41,0	110,0
T80-20,0	20,0	20,0	57,0	41,0	110,0
T80-22,0	22,0	20,0	55,0	41,0	110,0
T80-24,0	24,0	20,0	55,0	41,0	110,0
T80-26,0	26,0	25,0	55,0	41,0	110,0
T80-28,0*	28,0	25,0	55,0	41,0	110,0
T80-30,0*	30,0	25,0	55,0	41,0	110,0

* Not standard stock

Recommended cutting data

Material:	Hardox 400	Hardox 500	Hardox 600
Speed m/min:	30 - 80	30 - 80	25 - 70
Feed mm/rev:	0,10 - 0,25	0,05 - 0,15	0,04 - 0,12

HARDOX Drill HSS-Co

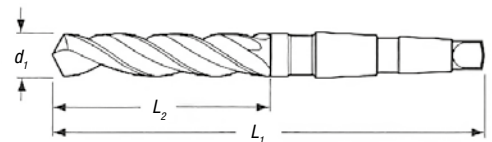

Part no.	d ₁	L ₁	L ₂	MT
HD-10,0	10	154	56	MT2
HD-10,5	10,5	154	56	MT2
HD-11,0	11	154	56	MT2
HD-11,5	11,5	159	61	MT2
HD-12,0	12	164	66	MT2
HD-12,5	12,5	164	66	MT2
HD-13,0	13	164	66	MT2
HD-13,5	13,5	168	70	MT2
HD-14,0	14	168	70	MT2
HD-14,5	14,5	171	73	MT2
HD-15,0	15	171	73	MT2
HD-15,5	15,5	175	77	MT2
HD-16,0	16	175	77	MT2
HD-16,5	16,5	178	80	MT2
HD-17,0	17	178	80	MT2
HD-17,5	17,5	182	84	MT2
HD-18,0	18	182	84	MT2
HD-18,5	18,5	203	86	MT3
HD-19,0	19	203	86	MT3
HD-19,5	19,5	207	90	MT3
HD-20,0	20	207	90	MT3

Part no.	d ₁	L ₁	L ₂	MT
HD-21,0	21	210	93	MT3
HD-22,0	22	213	96	MT3
HD-23,0	23	217	100	MT3
HD-24,0	24	219	102	MT3
HD-25,0	25	219	102	MT3
HD-26,0	26	222	105	MT3
HD-27,0	27	265	120	MT4
HD-28,0	28	265	120	MT4
HD-29,0	29	265	120	MT4
HD-30,0	30	265	120	MT4
HD-31,0	31	265	120	MT4
HD-32,0	32	265	120	MT4
HD-33,0	33	265	120	MT4
HD-34,0	34	265	120	MT4
HD-35,0	35	265	120	MT4
HD-36,0	36	265	120	MT4
HD-37,0	37	265	120	MT4
HD-38,0	38	265	120	MT4
HD-39,0	39	265	120	MT4
HD-40,0	40	265	120	MT4



Granlund Tools balancing stands for balancing of grinding wheels. Our balancing stands are also excellent for balancing axles, propellers, etc.

The balancing stands are manufactured for highest precision and accuracy when balancing. A good balanced grinding wheel results in less wear on the machine, a better grinding result and of course longer life of your grinding wheel.

- Harded and ground balancing discs are run on ball bearings.
- Suitable for static balancing of grinding wheels, axles and other rotating machine elements.

Part No.	Max. diameter of grinding wheel with balance Ø 25 mm	Minimum and maximum length for balancing*	Loading range
500	540 mm	80 - 500 mm	0,3 - 500 kg
800	810 mm	100 - 800 mm	0,3 - 700 kg

* Longer workpieces may be balanced with longer guiding bars.

Instruction for balancing of grinding wheels

General

Grinding wheels that are used for fine grinding, should be well balanced. If the wheel is unbalanced, vibrations will occur and cause a poor surface finish. The bearings in the grinding machine will also be affected and in worst case damaged.

Control of the grinding wheel

Check if wheel is broken by knocking on a freely hanging wheel. If the tone is clean, the wheel is intact.

Balancing

1. Remove the balancing weights from the centre of the wheel.
2. Put the wheel on a balancing axle and place it in the balancing stand.
3. Let the wheel swing back and forth until it stops. Mark the bottom part of the wheel with a chalk stick (1).
4. Place one of the weights (b1) on the opposite side, making the wheel rotate 180 degrees.
5. Thereafter put the weights b2 and b3 uniformly in relation to b1.
6. Move the weights b2 and b3 gradually from each other until the wheel stops to swing. The wheel is now balanced.

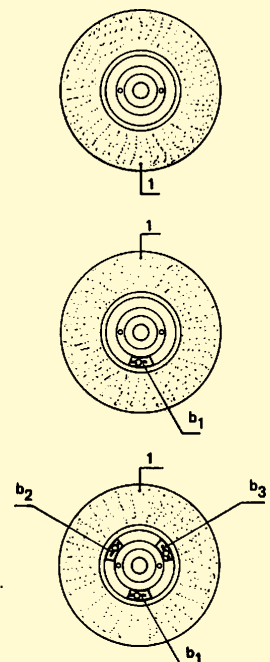

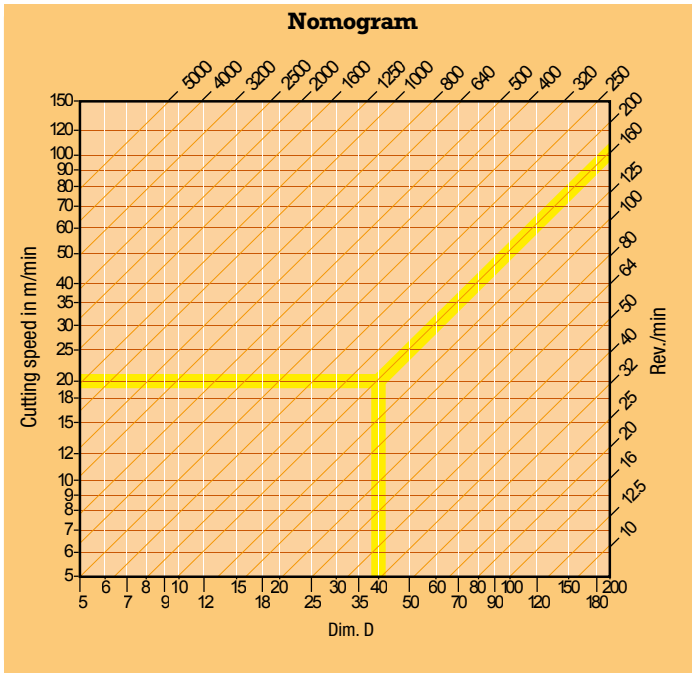

Type of tools D mm	Spare parts					
	Insert	Centre lock			Solid inserts	
	Size	Screw	Torx key	Clamp	Screw	Key
	Part No.	Part No.	Part No.	Part No.	Part No.	
WHV 18,0 - 25,0 KV 18,0 - 25,0 BV 18,0 - 26,0 FV 12,0 - 16,5 DFV 15,0 - 31,0 BFV 15,0 - 31,0 NE 13,0/26,0 - 17,0/26,0	07	SSK-20	TN-6	SK-3	SSK-3	TN-9
WHV 25,5 - 38,0 KV 26,0 - 30,0 BV 30,0 - 50,0 FV 20,0 - 30,0 NE 17,0/33,0 - 25,0/40,0	10	SSK-22	TN-7	SK-3	SSK-3	TN-9
WHV 34,0 - 45,0 KV 45,0	12	SSK-25	TN-7			
WHV 46,0 - KV 50,0 - NE 25,0/48,0 -	17	SSK-40	TN-15			

Troubleshooting

	1 Ovality	Reamer off centre or deformed workpiece due to poor fixture of workpiece.		6 Retraction marks	Back taper too large, or reamer off centre.
	2 Deformed hole	Too high feedrate in thin walled workpiece or poor fixture of workpiece.		7 Too large diameter	Adjusted diameter too large, poor fixture of workpiece.
	3 Curved hole	Axial misalignment of blade.		8 Vibrations at entry	Feedrate too low.
	4 Vibration marks	Too low feedrate or back taper too small.		9 Tapered hole	Reamer off centre, back taper too small.
	5 Poor surface finish	Too high cutting speed, poor coolant pressure, wrong coolant type or poor location of blade.		10 Pick up on pads	Wrong or too weak coolant mixture.



GRANLUND

Copyright © 2021 by Granlund Tools AB

EN-2022

Granlund Tools AB
Visiting address: Kungsgatan 90 • P.O. Box 377, SE-631 05 Eskilstuna, Sweden
Tel: +46(0)16-16 72 00 • info@granlund.se • www.granlund.com